

Cat. No. Z172-E1-02A

F160-2

Vision Sensor

**Manual 4:
Communications
REFERENCE MANUAL**

OMRON

READ AND UNDERSTAND THIS DOCUMENT

Please read and understand this document before using the products. Please consult your OMRON representative if you have any questions or comments.

WARRANTY

OMRON's exclusive warranty is that the products are free from defects in materials and workmanship for a period of one year (or other period if specified) from date of sale by OMRON.

OMRON MAKES NO WARRANTY OR REPRESENTATION, EXPRESS OR IMPLIED, REGARDING NON-INFRINGEMENT, MERCHANTABILITY, OR FITNESS FOR PARTICULAR PURPOSE OF THE PRODUCTS. ANY BUYER OR USER ACKNOWLEDGES THAT THE BUYER OR USER ALONE HAS DETERMINED THAT THE PRODUCTS WILL SUITABLY MEET THE REQUIREMENTS OF THEIR INTENDED USE. OMRON DISCLAIMS ALL OTHER WARRANTIES, EXPRESS OR IMPLIED.

LIMITATIONS OF LIABILITY

OMRON SHALL NOT BE RESPONSIBLE FOR SPECIAL, INDIRECT, OR CONSEQUENTIAL DAMAGES, LOSS OF PROFITS OR COMMERCIAL LOSS IN ANY WAY CONNECTED WITH THE PRODUCTS, WHETHER SUCH CLAIM IS BASED ON CONTRACT, WARRANTY, NEGLIGENCE, OR STRICT LIABILITY.

In no event shall responsibility of OMRON for any act exceed the individual price of the product on which liability is asserted.

IN NO EVENT SHALL OMRON BE RESPONSIBLE FOR WARRANTY, REPAIR, OR OTHER CLAIMS REGARDING THE PRODUCTS UNLESS OMRON'S ANALYSIS CONFIRMS THAT THE PRODUCTS WERE PROPERLY HANDLED, STORED, INSTALLED, AND MAINTAINED AND NOT SUBJECT TO CONTAMINATION, ABUSE, MISUSE, OR INAPPROPRIATE MODIFICATION OR REPAIR.

SUITABILITY FOR USE

THE PRODUCTS CONTAINED IN THIS DOCUMENT ARE NOT SAFETY RATED. THEY ARE NOT DESIGNED OR RATED FOR ENSURING SAFETY OF PERSONS, AND SHOULD NOT BE RELIED UPON AS A SAFETY COMPONENT OR PROTECTIVE DEVICE FOR SUCH PURPOSES. Please refer to separate catalogs for OMRON's safety rated products.

OMRON shall not be responsible for conformity with any standards, codes, or regulations that apply to the combination of products in the customer's application or use of the product.

At the customer's request, OMRON will provide applicable third party certification documents identifying ratings and limitations of use that apply to the products. This information by itself is not sufficient for a complete determination of the suitability of the products in combination with the end product, machine, system, or other application or use.

The following are some examples of applications for which particular attention must be given. This is not intended to be an exhaustive list of all possible uses of the products, nor is it intended to imply that the uses listed may be suitable for the products:

- Outdoor use, uses involving potential chemical contamination or electrical interference, or conditions or uses not described in this document.

- Nuclear energy control systems, combustion systems, railroad systems, aviation systems, medical equipment, amusement machines, vehicles, safety equipment, and installations subject to separate industry or government regulations.
- Systems, machines, and equipment that could present a risk to life or property.

Please know and observe all prohibitions of use applicable to the products.

NEVER USE THE PRODUCTS FOR AN APPLICATION INVOLVING SERIOUS RISK TO LIFE OR PROPERTY WITHOUT ENSURING THAT THE SYSTEM AS A WHOLE HAS BEEN DESIGNED TO ADDRESS THE RISKS, AND THAT THE OMRON PRODUCT IS PROPERLY RATED AND INSTALLED FOR THE INTENDED USE WITHIN THE OVERALL EQUIPMENT OR SYSTEM.

PERFORMANCE DATA

Performance data given in this document is provided as a guide for the user in determining suitability and does not constitute a warranty. It may represent the result of OMRON's test conditions, and the users must correlate it to actual application requirements. Actual performance is subject to the OMRON Warranty and Limitations of Liability.

CHANGE IN SPECIFICATIONS

Product specifications and accessories may be changed at any time based on improvements and other reasons.

It is our practice to change model numbers when published ratings or features are changed, or when significant construction changes are made. However, some specifications of the product may be changed without any notice. When in doubt, special model numbers may be assigned to fix or establish key specifications for your application on your request. Please consult with your OMRON representative at any time to confirm actual specifications of purchased products.

DIMENSIONS AND WEIGHTS

Dimensions and weights are nominal and are not to be used for manufacturing purposes, even when tolerances are shown.

ERRORS AND OMISSIONS

The information in this document has been carefully checked and is believed to be accurate; however, no responsibility is assumed for clerical, typographical, or proofreading errors, or omissions.

PROGRAMMABLE PRODUCTS

OMRON shall not be responsible for the user's programming of a programmable product, or any consequence thereof.

COPYRIGHT AND COPY PERMISSION

This document shall not be copied for sales or promotions without permission.

This document is protected by copyright and is intended solely for use in conjunction with the product. Please notify us before copying or reproducing this document in any manner, for any other purpose. If copying or transmitting this document to another, please copy or transmit it in its entirety.

F160-2 Vision Sensor

Manual 4: Communications Reference Manual

Revised June 2006

Notice:

OMRON products are manufactured for use according to proper procedures by a qualified operator and only for the purposes described in this manual.

The following conventions are used to indicate and classify precautions in this manual. Always heed the information provided with them. Failure to heed precautions can result in injury to people or damage to property.

 **DANGER** Indicates an imminently hazardous situation which, if not avoided, will result in death or serious injury.

 **WARNING** Indicates a potentially hazardous situation which, if not avoided, could result in death or serious injury.

 **Caution** Indicates a potentially hazardous situation which, if not avoided, may result in minor or moderate injury, or property damage.

OMRON Product References

All OMRON products are capitalized in this manual. The word “Unit” is also capitalized when it refers to an OMRON product, regardless of whether or not it appears in the proper name of the product.

Visual Aids

The following headings appear in the left column of the manual to help you locate different types of information.

Note Indicates information of particular interest for efficient and convenient operation of the product.

1,2,3... 1. Indicates lists of one sort or another, such as procedures, checklists, etc.

Precaution Indicates information required to take full advantage of the functions and performance of the product. Incorrect application methods may result in the loss of damage or damage to the product. Read and follow all precautionary information.

CHECK Indicates points that are important in using product functions or in application procedures.

TwoCamera Indicates information required when using a 2-camera system.

SeeAlso Indicates where to find related information.

HELP Indicates information helpful in operation, such as the definition of terms.

© OMRON, 2003

All rights reserved. No part of this publication may be reproduced, stored in a retrieval system, or transmitted, in any form, or by any means, mechanical, electronic, photocopying, recording, or otherwise, without the prior written permission of OMRON.

No patent liability is assumed with respect to the use of the information contained herein. Moreover, because OMRON is constantly striving to improve its high-quality products, the information contained in this manual is subject to change without notice. Every precaution has been taken in the preparation of this manual. Nevertheless, OMRON assumes no responsibility for errors or omissions. Neither is any liability assumed for damages resulting from the use of the information contained in this publication.

TABLE OF CONTENTS

SECTION 1

Parallel Interface	1
1-1 Setting Communications Specifications	2
1-2 I/O Format	4
1-3 Timing Charts	5

SECTION 2

Serial Interface Menu Operations	13
2-1 Setting Communications Specifications	14

SECTION 3

Normal Serial Interface	17
3-1 Setting Communications Specifications	19
3-2 Input Format (Normal)	24
3-3 Output Format (Normal)	61

SECTION 4

Host Link Serial Interface	63
4-1 Setting Communications Specifications	64
4-2 Input Format (Host Link)	70
4-3 Output Format (Host Link)	81
4-4 Sample Ladder Program	83

Index	87
--------------------	-----------

Revision History	91
-------------------------------	-----------

About this Manual:

This manual describes how to transmit data from the F160 Vision Sensor to an external device, and it includes the sections described below. This manual explains the menu operations and communications specifications required to establish communications as well as information on the I/O format and timing charts. This is one of four manuals used to operate the F160. Refer to the following table for the contents of each manual.

Manual	Contents	Cat. No.
1: Setup Manual	Provides information on system hardware and installation. Be sure to read this manual first.	Z170
2: Conversational Menu Operation Manual	Describes operation of the F160 using the Conversational Menus. The Conversational Menus enable the simplest operation based on registered images of acceptable and unacceptable products.	Z171
3: Expert Menu Operation Manual	Describes operation of the F160 using the Expert Menus. The Expert Menus enable application of all F160 capabilities, including setting region images and criteria.	Z173
4: Communications Reference Manual	Describes the communications settings and communications protocol used to transfer data through the parallel interface or serial interface.	Z172

Please read the above manuals carefully and be sure you understand the information provided before attempting to install or operate the F160.

Section 1 Parallel Interface explains the I/O format and the required communications settings when using the F160's parallel interface to communicate with external devices

Section 2 Serial Interface Menu Operations shows how to navigate through the F160's menu from a personal computer using keyboard inputs or inputting codes that correspond to Console keys.

Section 3 Normal Serial Interface explains how to use the F160's serial interface to communicate with an external device such as a personal computer using normal (no-protocol) communications. Communications through the serial interface are supported with the Expert Menus but not the Conversational Menus.

Section 4 Host Link Serial Interface explains how to use the F160's serial interface to communicate with an external device such as a programmable controller (PLC) using host link communications. Communications through the serial interface are supported with the Expert Menus but not the Conversational Menus.

 **WARNING** Failure to read and understand the information provided in this manual may result in personal injury or death, damage to the product, or product failure. Please read each section in its entirety and be sure you understand the information provided in the section and related sections before attempting any of the procedures or operations given.

SECTION 1

Parallel Interface

This section explains the I/O format and the required communications settings when using the F160's parallel interface to communicate with external devices.

1-1	Setting Communications Specifications	2
1-2	I/O Format	4
1-2-1	Input Format	4
1-2-2	Output Format	4
1-3	Timing Charts	5
1-3-1	Handshaking OFF	5
1-3-2	Handshaking ON	10
1-3-3	Executing Other Commands	11

1-1 Setting Communications Specifications

This section explains how to set the communications specifications. Set the same communications specifications in the F160 and the external device.

1. Move the cursor to **MON** or **RUN** and press the **ENT** Key.

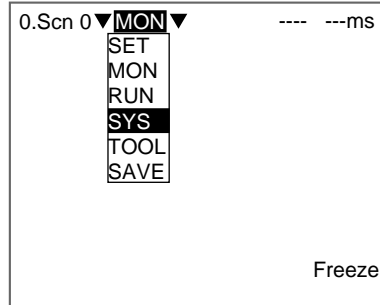

2. Select **SYS**.

The *System settings* menu will be displayed.

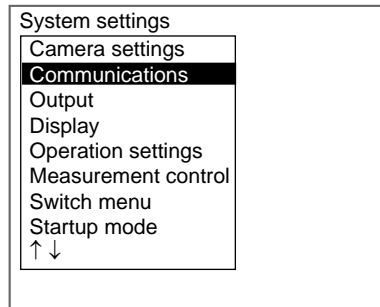

3. Select **Communications**.

The communications menu will be displayed.

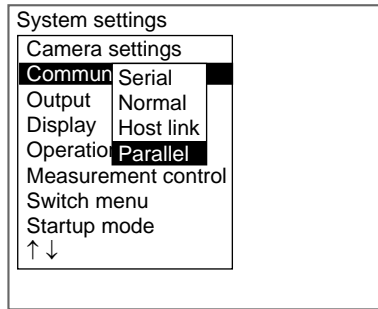

4. Select **Parallel**.

The *Communications (Parallel)* window will be displayed.

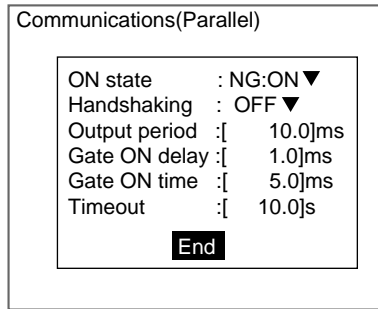

5. The Communications (Parallel) window will be displayed.

SeeAlso

Refer to the *Expert Menu Operation Manual* or the *Conversational Menu Operation Manual* for details on inputting numbers.

6. Select **End**.

The displayed settings will be registered and the *System settings* menu (from step 4) will be displayed.

The following table shows the possible communications settings.

Item		Settings
ON state		Select whether the OR and DO0 to DO15 signals will go ON when the judgement is OK or NG. (The default setting is ON for an NG judgement.)
Handshaking	OFF	The F160 outputs the measurement results without synchronizing with the external device. (This is the default setting.)
	ON	The F160 outputs the measurement results while synchronizing the transmission with the external device.
Output period (Effective only when handshaking is OFF.)		Set the period for outputting the measurement result. Set a value between 2.0 and 10,000.0 ms that is greater than the "Gate ON delay + Gate ON time," and less than the measurement interval. If the period is longer than the measurement interval, the output timing will fall behind as the measurements are repeated. The default setting is 10.0 ms.
Gate ON delay		Set the time from when the result is output to the parallel interface to when the GATE signal is turned ON. This time is used to wait until the data output becomes stable. Set a time between 1.0 and 1,000 ms that is longer than the external device's delay time. The default setting is 1.0 ms.

Item	Settings
Gate ON time (Effective only when handshaking is OFF.)	Set the length of time that the GATE signal remains ON. Set a value between 1.0 and 1,000 ms so that the external device can read the measurement result. The default setting is 5.0 ms.
Timeout (Effective only when handshaking is ON.)	A timeout error will occur if there is no response from the external device within the timeout time. Set a value between 0.5 and 120.0 s. The default setting at 10.0 s.

1-2 I/O Format

1-2-1 Input Format

The following commands can be input when the F160 is in Monitor or Run mode.

STEP Signal

A one-time measurement is performed if the STEP signal is turned ON.

DI0 to DI9 Signals

Signals DI0 to DI9 can input the following commands. Allow at least 1 ms after DI0 to DI8 are determined to be ON before turning DI9 ON. (In the following table, a "0" indicates the signal is ON, a "1" indicates the signal is OFF. A "*" indicates that the F160 does not read the bit status, so the bit status can be either 0 or 1.)

Command	Input command (DI)										Operation	
	Execute	Command					Information					
	9	8	7	6	5	4	3	2	1	0		
Continuous measurement	1	0	0	0	0	*	*	*	*	*	Measurements continue while the command is being input.	
Switch scene	1	0	1	0	0	Scene group number					Switches the scene to measure.	
Example	1	0	1	0	0	0	0	0	1	0	Switches to scene 2.	
Switch scene group	1	1	1	0	0						Switches the scene group data.	
Example	1	1	1	0	0	0	0	0	1	0	Switches to scene group 2.	
Re-register model (Expert menus only)	1	1	0	0	0	Region number					Registers the model again based on the last measurement image that was read. (This command is valid only if a Gray Search, Precise Search, Rotation Search, or Relative Search region is specified. Other region numbers will be ignored if they are specified.)	
Example	1	1	0	0	0	0	0	1	1	0	Re-registers the model of region 6.	

1-2-2 Output Format

Measurement results are output each time a measurement is made. Data is output only when the F160 is in Run Mode; data is not output when the F160 is in Monitor Mode. The user can select whether a signal is output when the judgement result is OK or when it is NG. The default setting is for a signal to be output when the judgement result is NG. Refer to page 2 for details.

Conversational Menus

Signal	Output function
OR	Outputs the overall judgement result. It is possible to change the items that are included in the overall judgement result. Refer to the <i>Conversational Menu Operation Manual</i> for more details.
DO0 to DO15	Output the judgement results for regions 0 to 15.

Expert Menus

Signal	Output function
OR	Outputs the overall judgement result. It is possible to change the items that are included in the overall judgement result. Refer to the <i>Expert Menu Operation Manual</i> for more details.
DO0 to DO15	<p>Judgement Result Outputs: Outputs the judgement results of the expressions that were set in 0 to 31 of Expression/Judge. (Judgements 0 to 15 are output first and judgements 16 to 31 are output second.)</p> <p>Measurement Result Outputs: When Parallel was selected as the data output destination in the SYS/Output device menu, these signals output the measurement values for expressions that were set in 0 to 31 of Expression/Data before outputting the judgement results. Refer to the <i>Expert Menu Operation Manual</i> for more details.</p> <ul style="list-style-type: none"> • Only integer values are output. (The real values are rounded to the nearest integer.) • Values in the range -32,768 to 32,767 can be output. A value of -32,768 will be output if the measurement is less than -32,768 and a value of 32,767 will be output if the measurement is greater than 32,767. • Data is output in 2' s complement format. <p>Block output of Expression/Judge measurement values</p> <p>Output only when these numbers have been set.</p>

CHECK After measurements have been made in Run Mode, the data that is output to the OR and DO signals is retained until new measurements are made in Run Mode. The status of these output is retained even if the F160 is switched from Run Mode to another Mode.

CHECK The initial value for output signals is OFF, but the signals may go ON about 0.5 seconds after the power is turned ON. Take any necessary precautions when these signals are read by external devices.

1-3 Timing Charts

1-3-1 Handshaking OFF

When handshaking is set to OFF, the F160 outputs measurement results to the external device without synchronizing communications. Monitor the F160's GATE signal from the external device and read the measurement results at the external device while the F160's GATE signal is ON.

Using the STEP Signal as the Measurement Trigger (Expert Menus)

Parallel Output for Both Judgement and Data Results

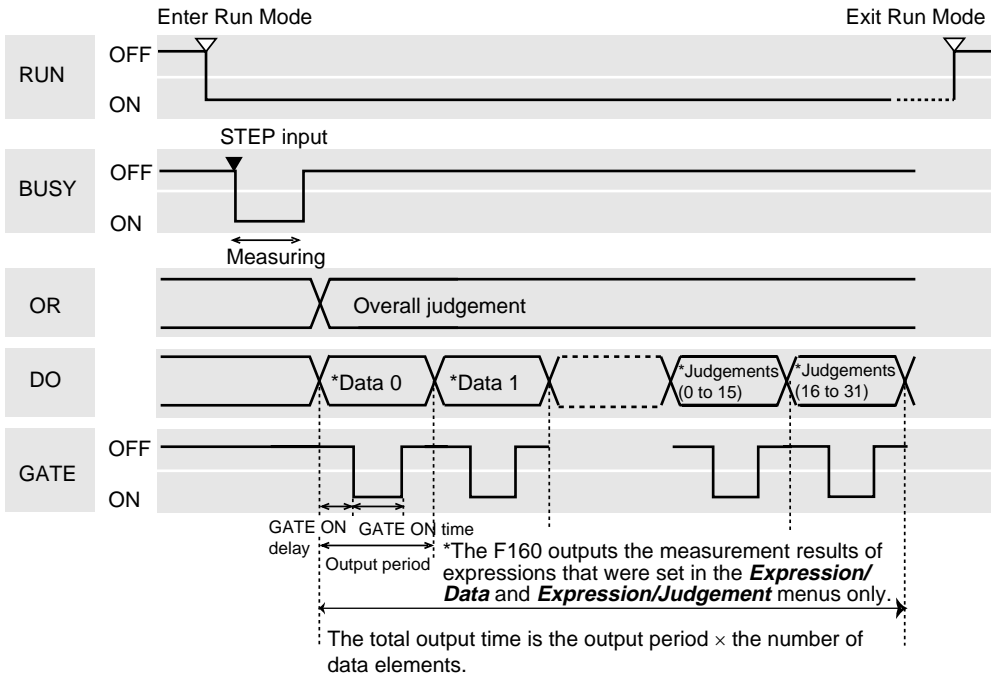

Parallel Output for Judgement, Serial Output for Data

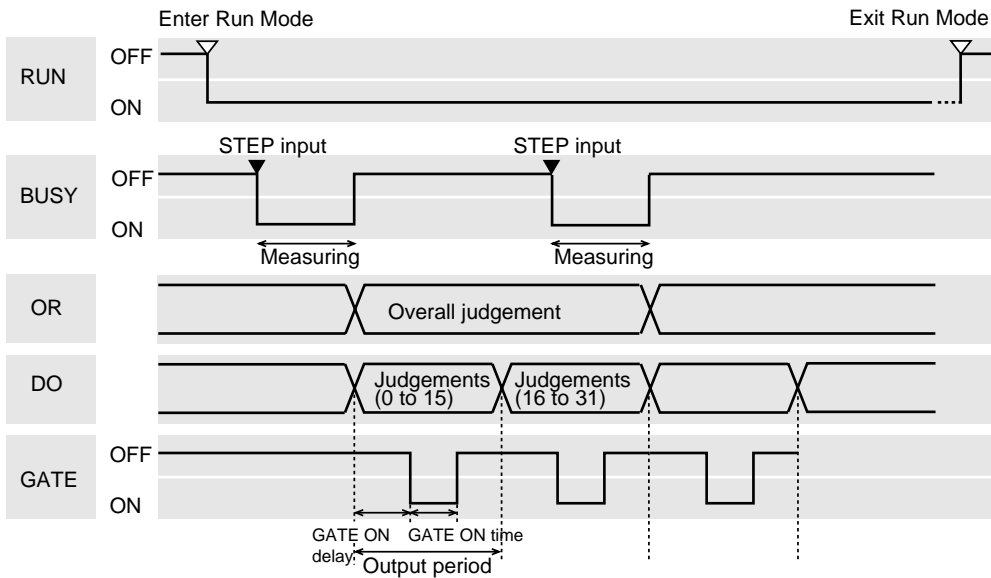

Output Signals

Signal	Function
RUN	ON while the F160 is in Run Mode.
BUSY	<p>Indicates that the F160 is performing an operation such as measuring or switching scenes. Do not input the next command while the BUSY signal is ON. If another command is input while the BUSY signal is ON, either the operation being performed or the command that was input may not be properly executed.</p> <p>When the BUSY signal's OFF timing is changed to Image Input Completed, the F160 will continue measuring even though the BUSY signal is OFF. Do not input the next command until the measurement is completed. Refer to the <i>Expert Menu Operation Manual</i> for more details.</p>
OR	<p>Outputs the overall judgement. The overall judgement will be NG if even one NG judgement result is returned for the measurement regions and expressions that are set.</p> <p>There is a parameter in the communications settings window that allows you to select whether the ON signal is output when the judgement result is OK or NG. Refer to page 2 for details.</p> <p>It is possible to change the items that are included in the overall judgement result. Refer to the <i>Expert Menu Operation Manual</i> for more details.</p>
DO	<p>Outputs the results of the expressions that were set in Expression/Judge and Expression/Data.</p> <p>There is a parameter in the communications settings window that allows you to select whether the ON signal is output when the judgement result is OK or NG. Refer to page 2 for details.</p>
GATE	<p>Use the GATE signal to control the timing for the external device to read measurement results. Set a GATE ON time that is long enough for the external device to read the measurement results properly.</p> <p>Set the output period so that the total output time is shorter than the measurement interval (STEP input interval.)</p>

Input Signals

Signal	Function
STEP	Input a measurement trigger from an external source such as a Photoelectric Sensor. Synchronize the STEP signal's rising edge (OFF-to-ON) transition and make one measurement. Keep the STEP signal ON for at least 0.5 ms.

CHECK**Busy Signal Operation**

The operation of the BUSY signal can be changed in the **SYS/Measurement control** window.

- Set the point in F160 processing when the BUSY signal is turned OFF. The BUSY signal can be set to go OFF when the image input is completed, the measurement is completed (default setting), or the display is completed.
- Set whether or not the ERR signal will be turned ON if another STEP signal is input while the F160 is still measuring.

SeeAlso

Refer to the *Expert Menu Operation Manual* for details.

Using the STEP Signal as the Measurement Trigger (Conversational Menus)

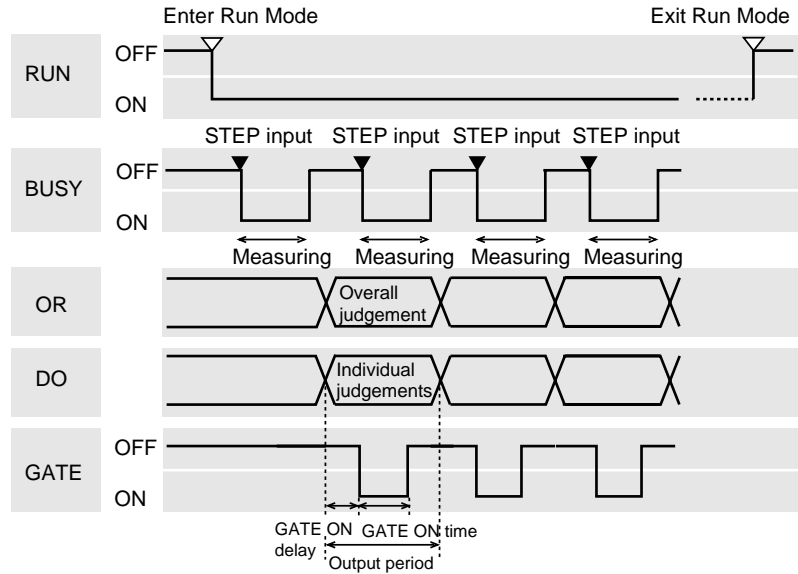

Output Signals

Signal	Function
RUN	ON while the F160 is in Run Mode.
BUSY	Indicates that the F160 is performing an operation such as measuring or switching scenes. Do not input the next command while the BUSY signal is ON. If another command is input while the BUSY signal is ON, either the operation being performed or the command that was input may not be properly executed. When the BUSY signal's OFF timing is changed to Image Input Completed , the F160 will continue measuring even though the BUSY signal is OFF. Do not input the next command until the measurement is completed. Refer to the <i>Conversational Menu Operation Manual</i> for more details.
OR DO	The overall judgement result is output through OR and the judgement results for individual regions are output through DO0 to DO15. There is a parameter in the communications settings window that allows you to select whether the ON signal is output when the judgement result is OK or NG. Refer to page 2 for details. It is possible to change the items that are included in the overall judgement result. Refer to the <i>Conversational Menu Operation Manual</i> for more details.
GATE	Use the GATE signal to control the timing for the external device to read measurement results. Set a GATE ON time that is long enough for the external device to read the measurement results properly. Set the output period so that the total output time is shorter than the measurement interval (STEP input interval.)

Input Signals

Signal	Function
STEP	Input a measurement trigger from an external source such as a Photoelectric Sensor. Synchronize the STEP signal's rising edge (OFF-to-ON) transition and make one measurement. Keep the STEP signal ON for at least 0.5 ms.

CHECK Busy Signal Operation

The operation of the BUSY signal can be changed in the **SYS/Measurement control** window.

- Set the point in F160 processing when the BUSY signal is turned OFF. The BUSY signal can be set to go OFF when the image input is completed, the measurement is completed (default setting), or the display is completed.
- Set whether or not the ERR signal will be turned ON if another STEP signal is input while the F160 is still measuring.

SeeAlso

Refer to the *Conversational Menu Operation Manual* for details.

Continuous Measurement

This example explains continuous measurement when the Expert Menus are being used.

CHECK

Set the output period so that the total output time is shorter than the measurement interval (STEP input interval.) If the output cycle is longer than the measurement cycle, the output will gradually fall behind as measurements are repeated.

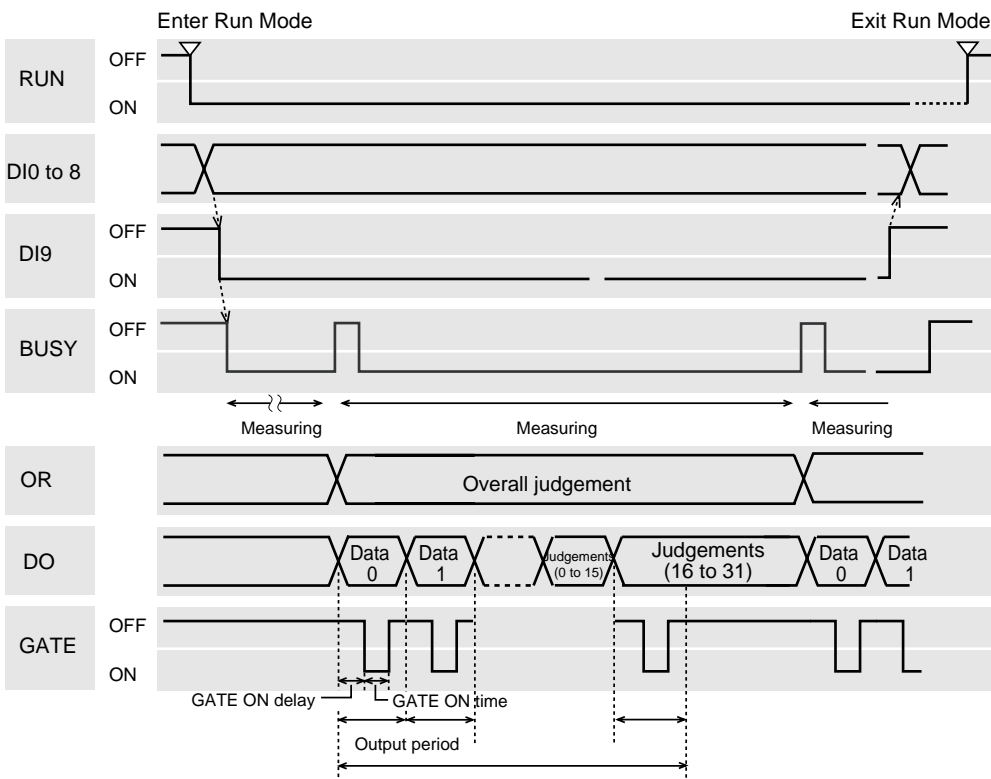

The total output time is the output period × the number of data elements.

Output Signals

The functions of the output signals are the same as they are when the STEP signal is used as the measurement trigger. (Refer to the tables on the preceding pages.)

Input Signals

Signal	Function
DI0 to DI4	OFF
DI5 and DI6	OFF

Signal	Function
DI7	OFF
DI8	OFF
DI9	DI9 is the execution trigger. After DI0 to DI8 are set, allow at least 1 ms before turning ON DI9.

1-3-2 Handshaking ON

When handshaking is set to ON, the F160 outputs measurement results to the external device while synchronizing communications. Handshaking is effective when multiple measurement results are output in numerical order and the handshaking function transfers data with more certainty.

Using the STEP Signal as the Measurement Trigger

Parallel Output for Both Judgement and Data Results

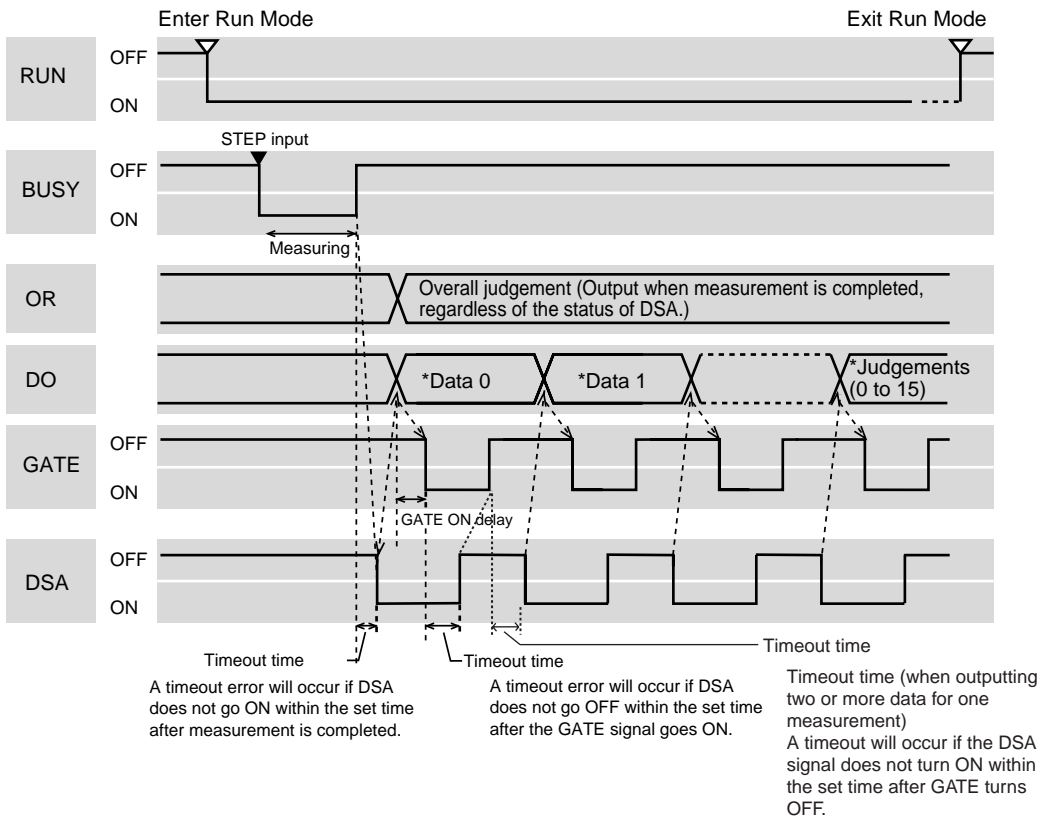

Note *The F160 outputs the measurement results of expressions that were set in the **Expression/Data** and **Expression/Judgement** menus only.

CHECK With the exception of DSA, the functions of the I/O signals are the same as they are when handshaking is set to OFF. The DSA signal is used only when handshaking is set to ON.

I/O Signals

Signal	Function
DSA	<p>DSA is the signal from the external device that requests transmission of the next batch of data. The F160 does not output data until DSA goes ON. Turn ON the DSA signal when the following conditions are met:</p> <ul style="list-style-type: none"> • The external device's data receiving system is ready to receive more data. • The F160 has completed measurements. <p>Generally, the BUSY signal will be ON while the F160 is measuring and the BUSY signal can be used to indicate when measurements are completed. If the BUSY signal's OFF timing has been changed to go OFF when image inputting is completed, the F160 may still be measuring even though the BUSY signal has gone OFF. (The BUSY signal's OFF timing is set in SYS/Measurement control.)</p> <p>Refer to the <i>Expert Menu Operation Manual</i> or the <i>Conversational Menu Operation Manual</i> for more details.</p>

1-3-3 Executing Other Commands

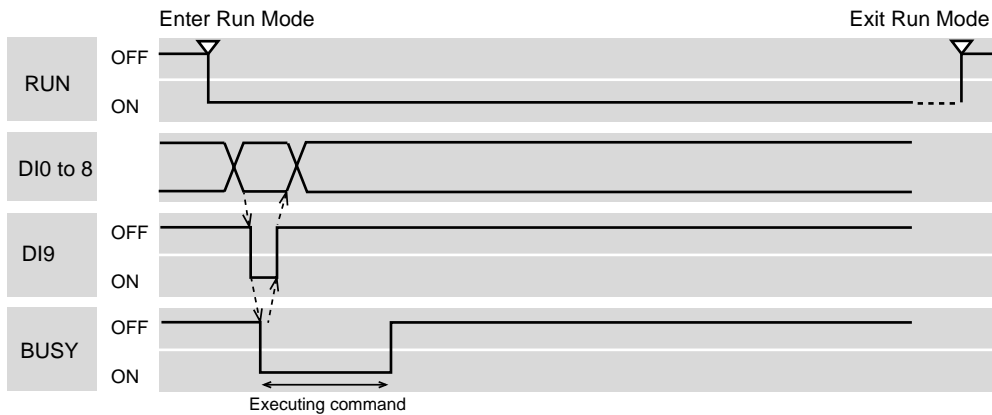

Output Signals

Signal	Function
RUN	ON while the F160 is in Run Mode.
BUSY	Indicates that the F160 is performing an operation such as measuring or switching scenes. Do not input the next command while the BUSY signal is ON. If another command is input while the BUSY signal is ON, either the operation being performed or the command that was input may not be properly executed.

Input Signals: Changing the Scene

Signal	Function
DI0 to DI4	Set the scene number (0 to 31).
DI5 and DI6	OFF
DI7	ON
DI8	OFF
DI9	<p>DI9 is the execution trigger.</p> <p>After DI0 to DI8 are set, allow at least 1 ms before turning ON DI9. The BUSY signal will be ON while the command is being executed.</p> <p>After confirming that the BUSY signal is ON, turn OFF DI9, and finally turn OFF DI0 to DI8.</p>

Input Signals: Changing the Scene Group

Signal	Function
DI0 to DI4	Set the scene group number (0 to 31).
DI5 and DI6	OFF
DI7 and DI8	ON
DI9	DI9 is the execution trigger. After DI0 to DI8 are set, allow at least 1 ms before turning ON DI9. The BUSY signal will be ON while the command is being executed. After confirming that the BUSY signal is ON, turn OFF DI9, and finally turn OFF DI0 to DI8.

Input Signals: Registering the Model Again

This command can be executed with the Expert Menus only.

Signal	Function
DI0 to DI4	Set the region number (0 to 31).
DI5 to DI7	OFF
DI8	ON
DI9	DI9 is the execution trigger. After DI0 to DI8 are set, allow at least 1 ms before turning ON DI9. The BUSY signal will be ON while the command is being executed. After confirming that the BUSY signal is ON, turn OFF DI9, and finally turn OFF DI0 to DI8.

SECTION 2

Serial Interface Menu Operations

This section shows how to navigate through the F160's menus from a personal computer using keyboard inputs or inputting codes that correspond to Console keys.

2-1	Setting Communications Specifications	14
2-1-1	Key Input and Console Key Correspondence	15
2-1-2	Inputting Characters from the Computer	16

2-1 Setting Communications Specifications

Set the same communications specifications in the F160 and the external device. The measurement results will be output in normal (no-protocol) format even if Menu Operation has been selected for the mode. The Xon/Xoff flow control cannot be used because the codes for the **Ctrl + S** and **Ctrl + Q** key inputs are duplicated.

1. Move the cursor to **MON** or **RUN** and press the **ENT** Key.

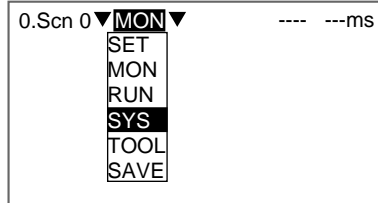

2. Select **SYS**.

The *System settings* menu will be displayed.

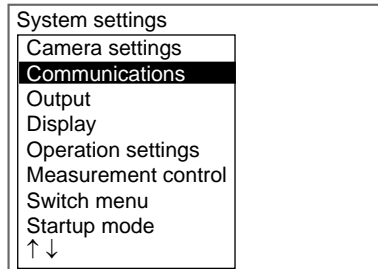

3. Select **Communications**.

The communications menu will be displayed.

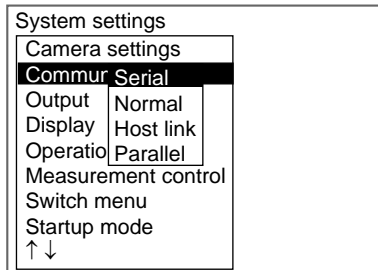

4. Select **Serial**.

The *Communications (Serial)* window will be displayed.

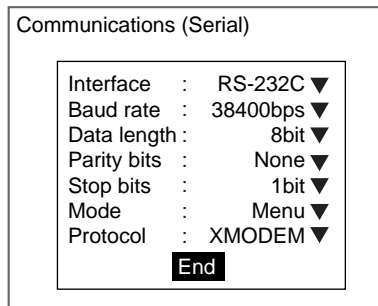

5. Set each parameter to the desired setting.
6. Select **End**.

The displayed settings will be registered and the System settings menu (from step 4) will be displayed.

The following table shows the possible communications settings. The asterisk indicates the factory default setting.

Item	Possible settings	
Interface	Select RS-232C . (from RS-232C* or RS-422)	
Baud rate (See note.)	2,400, 4,800, 9,600, 19,200, 38,400*, 57,600, 115,200 (bps)	Set the same settings that are set in the personal computer.
Data length	7 or 8* (bits)	
Parity bits	None*, Odd, or Even	
Stop bits	1* or 2 (bits)	
Mode	Select Menu . (from Menu, Normal*, or Host link)	
Protocol	XMODEM* or ZMODEM	

Note RS-232C standards are not defined for speeds over 20 kbps. Depending on the cable length, communications may be unreliable at speeds of 38,400 bps and higher when **RS-232C** is selected. If there are problems with communications, reduce the baud rate to 19,200 bps.

2-1-1 Key Input and Console Key Correspondence

Console Key	Input from RS-232C	
	Key	Code
ESC Key	CTRL + [(\$1B)
TRIG Key	CTRL + A	(\$01)
ENT Key	CTRL + M	(\$0D)
SHIFT + ESC Keys	CTRL + I, TAB	(\$09)
SHIFT + TRIG Keys	CTRL + T	(\$14)
SHIFT + ENT Keys	CTRL + R	(\$12)
Left Key	CTRL + S	(\$13)
Up Key	CTRL + E	(\$05)
Right Key	CTRL + D	(\$04)
Down Key	CTRL + X	(\$18)
SHIFT + Left Keys	CTRL + F	(\$06)
SHIFT + Up Keys	CTRL + W	(\$17)
SHIFT + Right Keys	CTRL + H	(\$08)
SHIFT + Down Keys	CTRL + Z	(\$1A)
F1 Key	CTRL + C	(\$03)
F2 Key	CTRL + V	(\$16)
F3 Key	CTRL + B	(\$02)
F4 Key	CTRL + N	(\$0E)
F5 Key	CTRL + J	(\$0A)
F6 Key	CTRL + K	(\$0B)
F7 Key	CTRL + L	(\$0C)
F8 Key	CTRL + O	(\$0F)
F9 Key	CTRL + P	(\$10)
--- (See note.)	CTRL + Q	(\$11)

Note Changes the serial interface input to normal (no-protocol) mode. This input is valid only in Monitor Mode and Run Mode.

2-1-2 Inputting Characters from the Computer

The computer can be used to input filenames and comments that will be displayed on-screen. Characters can be input only when the software keyboard is being displayed on the F160.

Enclose the input characters within double quotation marks.

Example: "LABEL"

CHECK Characters can be input in normal (no-protocol) mode.

CHECK The following characters cannot be used: ¥ / : . , ; * ? " < > | &

SECTION 3

Normal Serial Interface

This section explains how to use the F160's serial interface to communicate with an external device such as a personal computer.

3-1	Setting Communications Specifications	19
3-1-1	Operational Flowcharts	19
3-1-2	F160 Settings.	21
3-2	Input Format (Normal)	24
3-2-1	DATASAVE.	26
3-2-2	DATE.	26
3-2-3	DISPCOND: Display Condition	27
3-2-4	DISPIMG: Display Image.	28
3-2-5	EXP: Expression	29
3-2-6	EXPPARA (EP): Expression Parameter	29
3-2-7	IMGLOAD: Image Load.	30
3-2-8	IMGLOADM: Image Load Memory Card	30
3-2-9	IMGSAVE: Image Save	31
3-2-10	IMGSAVEM: Image Save Memory Card	31
3-2-11	LITPARA: Light Parameter	32
3-2-12	MEASDATA (MD): Measure Data.	33
3-2-13	MEASPARA (MP): Measure Parameter.	38
3-2-14	MEASURE (M).	50
3-2-15	MENUKEY.	51
3-2-16	MODELSET	51
3-2-17	PASSWORD	52
3-2-18	POSIAMNT: Position Amount	52
3-2-19	POSIDATA (PD): Position Data	53
3-2-20	POSIPARA (PP): Position Parameter	54
3-2-21	RESET.	55
3-2-22	SCENE	55
3-2-23	SCNLOAD: Scene Load	55
3-2-24	SCNLOADM: Scene Load Memory Card	56
3-2-25	SCNSAVE: Scene Save	56
3-2-26	SCNSAVEM: Scene Save Memory Card	57
3-2-27	SCNGROUP: Scene Group.	57
3-2-28	SGRLOAD: Scene Group Load	58
3-2-29	SGRLOADM: Scene Group Load Memory Card.	58

3-2-30	SGRSAVE: Scene Group Save	59
3-2-31	SGRSAVEM: Scene Group Save Memory Card.....	59
3-2-32	SYSLOAD: System Load	59
3-2-33	SYSLOADM: System Load Memory Card	60
3-2-34	SYSSAVE: System Save.....	60
3-2-35	SYSSAVEM: System Save Memory Card	61
3-2-36	VERGET: Version Get	61
3-3	Output Format (Normal)	61

3-1 Setting Communications Specifications

If the communications mode is set to **Normal**, the F160 can communicate with an external device such as a personal computer through its serial interface using the normal (no-protocol) format.

- **Setting Mode**
Command inputs are not received.
- **Monitor Mode**
Command inputs are received, but the measurement results are not output to external devices. Only the command execution result (OK or ER) is output.
When a command is input to read a set value, the appropriate value will be output.
- **Run Mode**
Command inputs are received and measurement results are output.

CHECK

After measurements have been made in Run Mode, the data up through the last measurement will be output even if the mode is changed to another mode. The data output will not be interrupted midway.

3-1-1 Operational Flowcharts

Serial Interface with I/O

A single F160 can be connected (1:1 connection) or more than one F160 can be connected (multi-drop connection.)

1:1 Connection

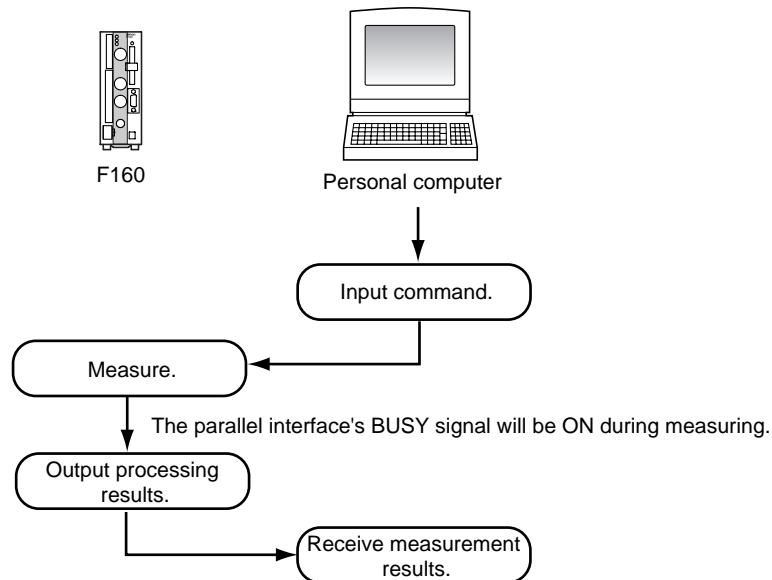

Note When the **Flow control** is set to **Xon/off** and a response is not received from the computer within the specified timeout time, a timeout error will occur because the computer may be disconnected or malfunctioning. An error message will be displayed on the F160's screen and the parallel interface's ERR signal will be turned ON.

Multi-drop Connection (1:N)

Branching Link Adapters can be used to connect up to 31 F160s to a single host computer. An identifying unit number is attached to the beginning of each

batch of communications data, so a unique unit number must be set in each F160 in the network.

SeeAlso Refer to page 23 for details on setting the unit number.

In the following example, a measurement command is input for the F160 with unit number 01 and those results are read.

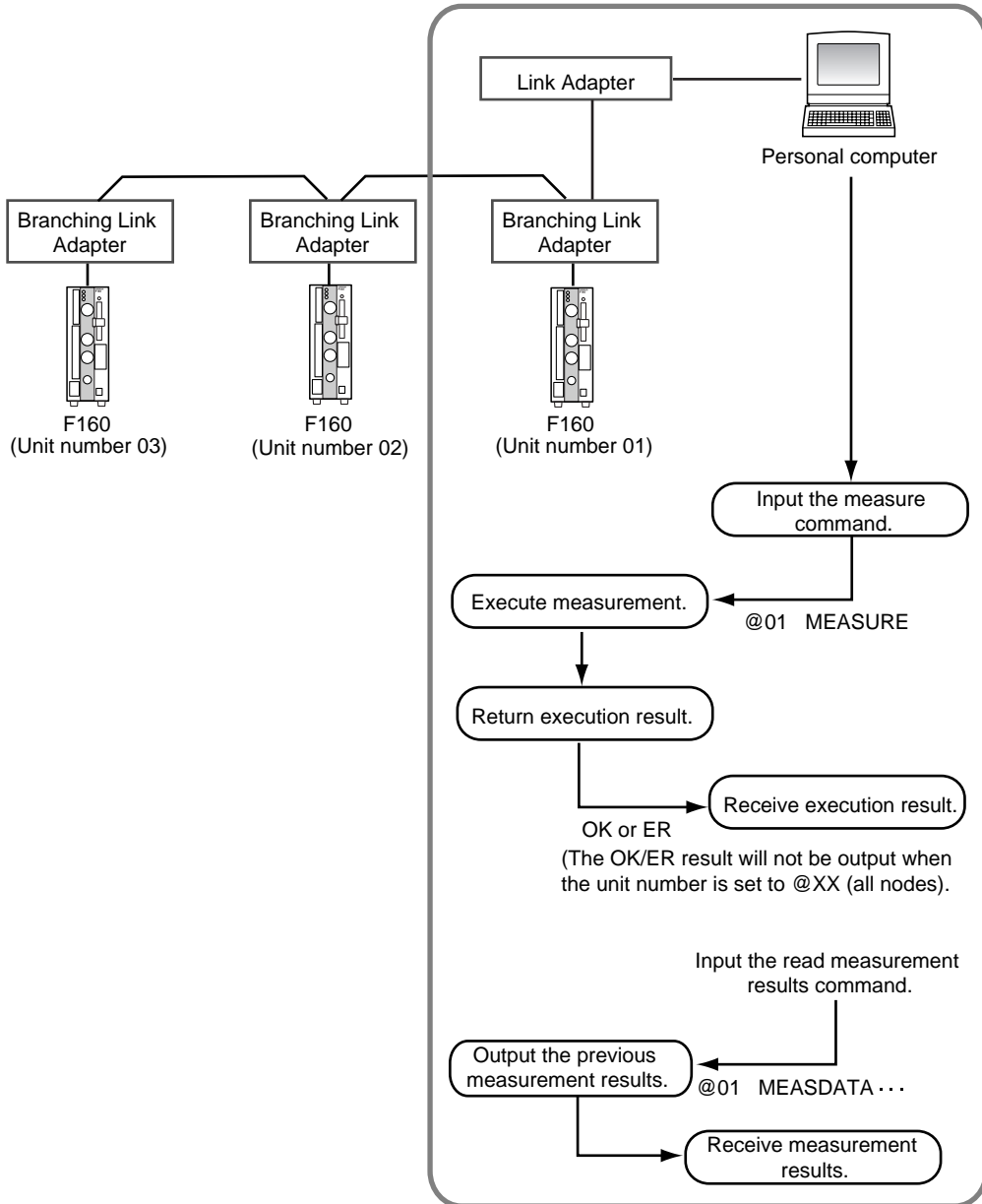

Inputting the Measurement Trigger from the STEP Signal

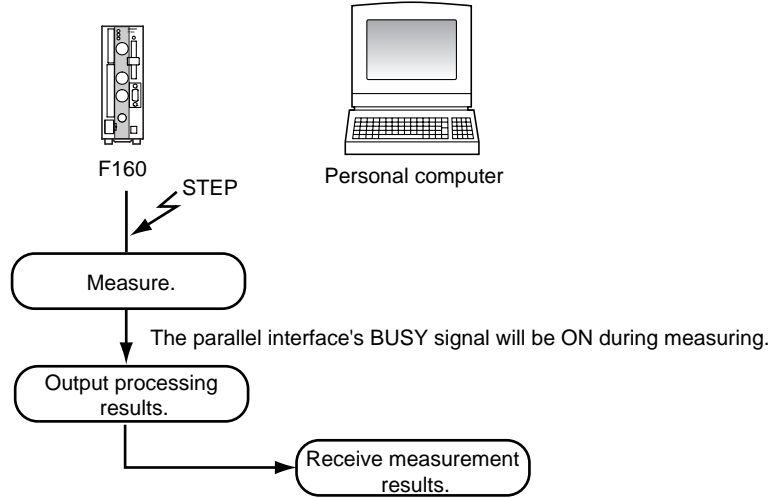

Note When the **Flow control** is set to **Xon/off** and a response is not received from the computer within the specified timeout time, a timeout error will occur because the computer may be disconnected or malfunctioning. An error message will be displayed on the F160's screen and the parallel interface's ERR signal will be turned ON.

3-1-2 F160 Settings

Communications Speed and Communications Mode

Use the following procedure to set communications specifications such as the baud rate and data length. Set the same communications specifications in the F160 and the external device.

1. Move the cursor to **MON** or **RUN** and press the **ENT** Key.

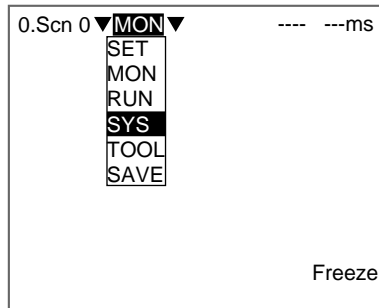

2. Select **SYS**.

The *System settings* menu will be displayed.

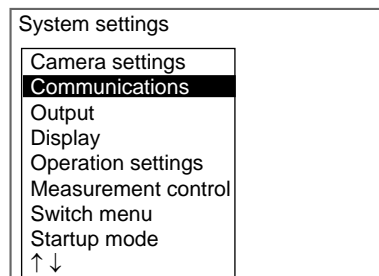

3. Select **Communications**.

The communications menu will be displayed.

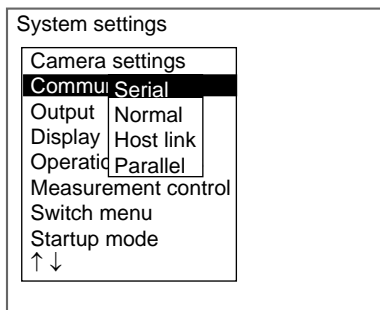

4. Select **Serial**.

The *Communications (Serial)* window will be displayed.

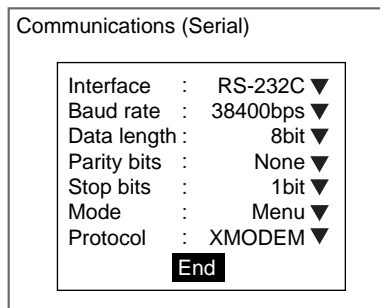

5. Set each parameter to the desired setting.
6. Select **End**.

The displayed settings will be registered and the *System settings* menu (from step 4) will be displayed.

The following table shows the possible communications settings. The asterisk indicates the factory default setting

Item	Possible settings
Interface	Select RS-232C . (from RS-232C* or RS-422)
Baud rate	2,400, 4,800, 9,600, 19,200, 38,400*, 57,600, 115,200 (bps)
Data length	7 or 8* (bits)
Parity bits	None*, Odd, or Even
Stop bits	1* or 2 (bits)
Mode	Select Normal . (from Menu, Normal*, or Host link)
Protocol	XMODEM* or ZMODEM

Note RS-232C standards are not defined for speeds over 20 kbps. Depending on the cable length, communications may be unreliable at speeds of 38,400 bps and higher when **RS-232C** is selected. If there are problems with communications, reduce the baud rate to 19,200 bps.

CHECK

Make the following settings when saving or loading with commands such as SCNLOAD and SCNSAVE.

Item	Possible settings
Data length	8 bits
Parity bits	None

Item	Possible settings
Stop bits	1 bit
Flow control	None

SeeAlso

Refer to page 24 for details on setting the flow control.

Settings for Flow Control and Multi-drop Connections

1. Select **Normal** communications

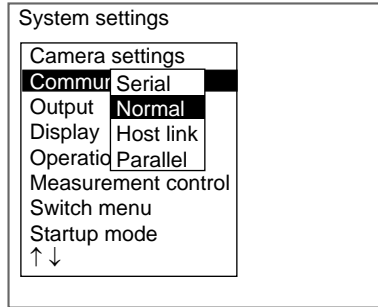

The *Communications (Normal)* window will be displayed.

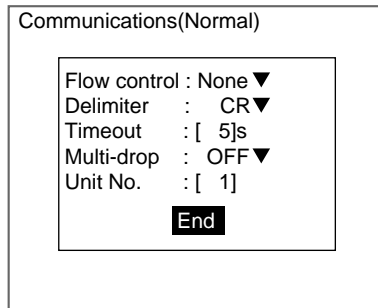

2. Set the various communications parameters.

SeeAlso

Refer to the *Expert Menu Operation Manual* or the *Conversational Menu Operation Manual* for details on inputting numbers.

3. Select **End**.

The new settings will be registered and the display will revert to the System settings window shown in step 1.

The following table shows the possible communications settings. The asterisk indicates the factory default setting.

Item	Possible settings	
Flow control	None*	Flow control is not performed. Use this setting when saving or loading with commands such as SCNLOAD and SCNSAVE.
	Xon/Xoff	Flow control is performed by software. Data is transmitted according to the Xon/Xoff codes sent from the external device.
Delimiter	CR*	Use the same setting that is being used in the personal computer.
	LF	
	CR + LF	
Timeout	Sets the time (in seconds) allowed before a timeout error is generated. (1 to 120 s, factory default setting: 5 s)	

Item	Possible settings	
Multi-drop	OFF*	Multi-drop connections are not used. If a unit number is set, it will be ignored.
	ON	Multi-drop connections are used. With multi-drop connections, results are not output even in Run Mode. To read measurement results, a MEASDATA command must be input from the external device. Refer to page 33 for details.
Unit No.	When multi-drop connections are used, set the F160's unique unit number. (1 to 31, factory default setting: 1)	

HELP Flow control checks the conditions of the external device during communications. If a response is not received from the external device within the timeout time, a timeout error is generated and an error message is displayed on the F160. The parallel interface's ERR signal is also turned ON.

3-2 Input Format (Normal)

The following commands can be input from the host computer to the F160. Common commands have abbreviations that are shown in parentheses. Unify the communications specifications in the F160 and external device before initiating communications.

Commands that Control F160 Operations

Use the following commands to execute operations in the F160, such as executing measurements and switching scenes.

Command	Function	Page
DISPCOND	Read the current image display conditions.	page 27
	Change the current image display conditions.	page 28
DISPIMG	Reads the memory number containing the image being displayed.	page 28
	Changes the display image.	page 28
MEASURE(M)	Executes one measurement.	page 50
	Executes one measurement on the image being displayed.	page 50
	Starts continuous measurement.	page 51
	Stops continuous measurement.	page 51
MENUKEY	Switches the serial interface input to Menu Operation.	page 51
MODELSET	Registers the specified region's model again.	page 51
RESET	Resets the F160.	page 55
SCENE	Reads the scene number being used.	page 55
	Switches the scene number.	page 55
SCNGROUP	Reads the scene group number being used.	page 57
	Switches the scene group number.	page 57

Commands that Read Measurement Results

Use the following commands to read the previous measurement results.

Command	Function	Page
POSIDATA(PD)	Reads the position compensation region's measurement results.	page 53
MEASDATAI(MD)	Reads the measurement region's measurement results.	page 33

Command	Function	Page
EXP	Reads the expression region's measurement results.	page 29
POSIAMNT	Reads the position compensation amount.	page 52

Commands that Save and Load Data

Use the following commands to backup data set in the F160 and stored images.

Command	Function	Page
DATASAVE	Saves the scene group data and system data being used.	page 26
IMGLOAD	Loads image data from an external device.	page 30
IMGSAVE	Saves image data to an external device.	page 31
SCNLOAD	Loads scene data from an external device.	page 55
SCNSAVE	Saves scene data to an external device.	page 56
SYSLOAD	Loads system data from an external device.	page 59
SYSSAVE	Saves system data to an external device.	page 60
SGRLOAD	Loads scene group data from an external device.	page 58
SGRSAVE	Saves scene group data to an external device.	page 59
IMGLOADM	Loads image data from a Memory Card.	page 30
IMGSAVEM	Saves image data to a Memory Card.	page 31
SCNLOADM	Loads scene data from a Memory Card.	page 56
SCNSAVEM	Saves scene data to a Memory Card.	page 57
SYSLOADM	Loads system data from a Memory Card.	page 60
SYSSAVEM	Saves system data to a Memory Card.	page 61
SGRLOADM	Loads scene group data from a Memory Card.	page 58
SGRSAVEM	Saves scene group data to a Memory Card.	page 59

Commands that Read or Change Current Settings

Use the following commands to read and change settings such as judgement conditions. Operations can be specified that change a value while retrieving the F160's setting.

Command	Function	Page
POSIPARA(PP)	Read or set the position compensation region's parameters.	page 54
MEASPARA(MP)	Read or set the measurement region's parameters.	page 38
EXPPARA(EP)	Read the judgement conditions for the expression (judgement and variables).	page 29
	Set the judgement conditions for the expression (judgement and variables).	page 30
LITPARA	Read or set the Intelligent Light's light levels.	page 32
VERGET	Read the system's version information.	page 61
DATE	Read the current date and time.	page 26
	Set the date and time.	page 27
PASSWORD	Read the password.	page 52

Format (Normal)

The commands are listed in alphabetical order. Input the commands in ASCII code. Either upper-case or lower-case characters can be input.

Example 1

Format for 1:1 Connection

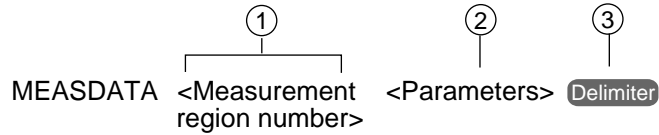

Example 2

Format for Multi-drop Connections (1:N Connections)

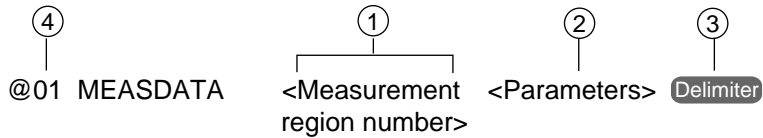

1. Set numerical values for the items in <> brackets.
2. Input a space between each parameter. (A space is not needed before the delimiter.)
3. Input the delimiter at the end of the command.
4. When multi-drop connections are being used, set the F160's unit number (@01 to @31) at the beginning of the command.
When you want to broadcast a command to all of the connected F160s, input @XX instead of a unit number. The F160s will not return responses to a broadcast command.

3-2-1 DATASAVE

Function

Saves the scene group data and system data that are being used. (Data for scene group 0 is saved to flash memory, data for scene groups 1 to 31 is saved to the Memory Card, and the system data is saved to the Memory Card.)

Input

DATASAVE Delimiter

Output

Command executed correctly: OK Delimiter
 Command not executed correctly: ER Delimiter

Precaution Do not turn OFF the F160's power supply until a response has been received.

3-2-2 DATE

Function 1

Reads the current date and time.

Input

DATE Delimiter

Output

Command executed correctly:
 Month Day Hour Minute Year. Second Delimiter
 OK Delimiter

Command not executed correctly:
ER Delimiter

Example

This example returns the time and date at 12:30:00 on August, 30 2000.

Input DATE Delimiter
Output Output 083012302000.00 Delimiter
OK Delimiter

Function 2

Sets the date and time.

Input

DATE <Month Day Hour Minute Year (first 2 digits) Year (last 2 digits). Seconds> Delimiter

Input item	Range	Remarks
Month	01 to 12	---
Day	01 to 31	---
Hour	00 to 23	---
Minute	00 to 59	---
Year (first 2 digits)	19 or 20	All four digits can be omitted or just the first two digits can be omitted.
Year (last 2 digits)	00 to 99	
Second	00 to 59	These two digits can be omitted.

Output

Command executed correctly: OK Delimiter
Command not executed correctly: ER Delimiter

Example

This example sets the time and date to 12:30:00 on August, 30 2000.

Input DATE 083012302000.00 Delimiter
Output OK Delimiter

3-2-3 DISPCOND: Display Condition

Function 1

Reads the current image display conditions.

Input

DISPCOND Delimiter

Output

Command executed correctly: Condition code Delimiter
OK Delimiter
Command not executed correctly: ER Delimiter

Condition code	Meaning
0	Freeze
1	Through
2	Last NG (no good)
3	Reduction: Freeze
4	Reduction: Through
5	Reduction: Last NG (no good)

Example

This example shows the output response when the display image is in “freeze.”

```
Input  DISPCOND Delimiter
Output 0 Delimiter
       OK Delimiter
```

Function 2

Changes the image display condition to the specified condition.

Input

DISPCOND <Condition code> Delimiter

The condition codes are the same as shown for *Function 1* above.

Output

```
Command executed correctly:  OK Delimiter
Command not executed correctly: ER Delimiter
```

Example

This example shows how to change the display image to the “Reduction freeze” condition.

```
Input  DISPCOND 3 Delimiter
Output OK Delimiter
```

3-2-4 DISPIMG: Display Image**Function 1**

Reads the memory number containing the image that is currently being displayed.

Input

DISPIMG Delimiter

Output

```
Command executed correctly:  Memory number Delimiter
                           OK Delimiter
Command not executed correctly: ER Delimiter
```

CHECK

A value of -1 will be output when “Through”, “Freeze”, “Last NG”, “Reduction: Freeze”, “Reduction: Through”, or “Reduction: Last NG” is being displayed.

Example

In this example, the image in memory number 12 is being displayed.

```
Input  DISPIMG Delimiter
Output OK Delimiter
```

Function 2

Changes the display image.

Input

DISPIMG <Memory number> Delimiter

- Set the memory number between -1 and 35.
- When -1 is specified, the display condition set with DISPCOND or in the Display settings window (for example, “Through” or “Freeze”) will be used.

Output

Command executed correctly: OK Delimiter
 Command not executed correctly: ER Delimiter

Example

This example shows how to display the image in memory number 8.

Input DISPIMG 8 Delimiter
 Output OK Delimiter

3-2-5 EXP: Expression**Function**

Reads the expression's measurement results.

Input

EXP <Output code> <Output number> Delimiter

Item	Output code	Output number
Variable	0	0 to 31
Data	1	0 to 31
Judgement	2	0 to 31

Output

Command executed correctly: Measured value Delimiter
 OK Delimiter
 Command not executed correctly: ER Delimiter

Example

This example reads the measured value of the data 0. The measured value is 28.195.

Input EXP 1 0 Delimiter
 Output 28.195 Delimiter
 OK Delimiter

3-2-6 EXPPARA (EP): Expression Parameter**Function 1**

Reads the judgement conditions for the expression (judgement and variables).

Input

EXPPARA <Output code> <Output number> <Parameter> Delimiter

Item	Output code	Output number	Parameter
Variable	0	0 to 31	0: Upper limit
Judgement	1		1: Lower limit

Output

Command executed correctly: Judgement condition Delimiter
 OK Delimiter
 Command not executed correctly: ER Delimiter

Example

This example reads the upper limit of judgement 0. (The upper limit of judgement 0 is 100.000.)

Input EP 1 0 0 Delimiter

Output 100.000 Delimiter
OK Delimiter

Function 2

Set the judgement conditions for the expression (judgement and variables).

Input

EXPPARA <Output code> <Output number> <Parameter> <New setting>
Delimiter

Item	Output code	Output number	Parameter	New setting
Variable	0	0 to 31	0: Upper limit	-9,999,999.999 to
Judgement	1		1: Lower limit	9,999,999.999

Output

Command executed correctly: Judgement condition Delimiter
OK Delimiter
Command not executed correctly: ER Delimiter

Example

This example changes the upper limit of judgement 0 to 150.000.

Input EP 1 0 0 150.000 Delimiter
Output OK Delimiter

3-2-7 IMGLOAD: Image Load

Function

Loads image data from an external device.

Input

IMGLOAD <Memory number> Delimiter

The memory number (0 to 35) specifies the destination for the image data being loaded from the external device.

Output

Command executed correctly: OK Delimiter
Command not executed correctly: ER Delimiter

CHECK

The image transfer is performed with XMODEM (-CRC or SUM) or ZMODEM protocol. (The XMODEM (-1K) protocol is not supported.)
The F160 sends the character string "READY" to the external device when the F160 has completed its initialization.

Example

This example loads image data from the external device to memory 2.

Input IMGLOAD 2 Delimiter
Output OK Delimiter

3-2-8 IMGLOADM: Image Load Memory Card

Function

Loads image data from a Memory Card.

Input

IMGLOADM <Memory number> <Filename> Delimiter

- The memory number (0 to 35) specifies the destination for the image data being loaded from the Memory Card.
- Add the filename extension .BMP to the filename.
- Specify the absolute path from the root directory.

Output

Command executed correctly: OK Delimiter
Command not executed correctly: ER Delimiter

Example

This example loads the file "LABEL1.BMP" in the Memory Card slot directory DIR01 to memory 2.

Input IMGLOADM 2 /C0/DIR01/LABEL1.BMP Delimiter
Output OK Delimiter

3-2-9 IMGSAVE: Image Save

Function

Saves image data in an external device.

Input

For XMODEM transfers: IMGSAVE <Memory number> Delimiter
For ZMODEM transfers: IMGSAVE <Memory number> <Filename> Delimiter

The memory number (0 to 35) specifies the memory location containing the image data that you want to save to the external device.

Output

Command executed correctly: OK Delimiter
Command not executed correctly: ER Delimiter

CHECK

The data transfer is performed with XMODEM (-CRC or SUM) or ZMODEM protocol. (The XMODEM (-1K) protocol is not supported.)
The Controller sends the character string "READY" to the external device when the Controller has completed preparations.
Wait for the "READY" string to be received at the external device before starting the data transfer.

Example

This example saves the image data contained in memory 2 to the external device.

Input IMGSAVE 2 Delimiter
Output OK Delimiter

3-2-10 IMGSAVEM: Image Save Memory Card

Function

Saves image data to a Memory Card.

Input

IMGSAVEM <Memory number> <Filename> Delimiter

- The memory number (0 to 35) specifies the memory location containing the image data that you want to save to the Memory Card.
- Add the filename extension .BMP to the filename.
- Specify the absolute path from the root directory.

Output

Command executed correctly: OK Delimiter
 Command not executed correctly: ER Delimiter

Example

This example saves the image data contained in memory 2 as the file "LABEL1.BMP" in Memory Card slot directory DIR01.

Input IMGSAVEM 2 /C0/DIR01/LABEL1.BMP Delimiter
 Output OK Delimiter

3-2-11 LITPARA: Light Parameter

Function 1

Reads the Intelligent Light's light levels.

Input

LITPARA <Camera number> Delimiter
 Specify the desired camera (0 or 1) with the camera number.

Output

Command executed correctly: Light level Delimiter
 OK Delimiter
 Command not executed correctly: ER Delimiter

- Depending on the model of Light connected, the light level is output as a 5-digit number or 8-digit number. Each digit represents the light level in a region of the light. The light level in each region of the light can be between 0 and 7, where 0 is OFF and 7 is maximum light level.
- F150-LTC20 and F150-LTC20

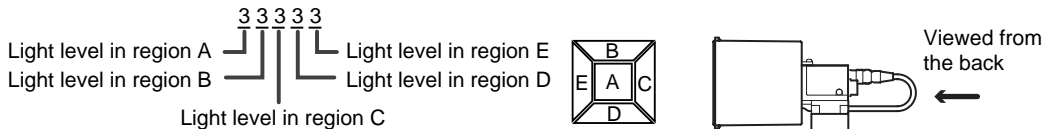

- F150-LTC50 and F150-LTC50

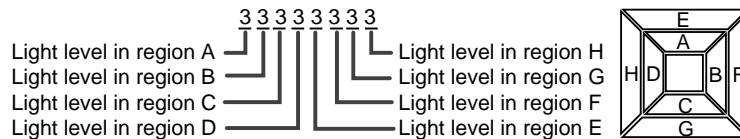

Example

This example reads the light levels set in an F160-LTC20 Intelligent Light connected as camera 0.

Input LITPARA 0 Delimiter
 Output 0555 Delimiter
 OK Delimiter

The following diagram shows these light level settings.



Function 2

Sets the Intelligent Light's light levels.

Input

LITPARA <Camera number> <Light levels> Delimiter

- Specify the desired camera (0 or 1) with the camera number.
- Input the light levels as a 5-digit number if the Light has 5 regions or an 8-digit number if the Light has 8 regions. (See *Function 1* above for details.) Each digit represents the light level in a region of the Light. The light level in each region can be set to one of 8 levels (0 to 7), where 0 is OFF and 7 is maximum light level.

Output

Command executed correctly: OK Delimiter

Command not executed correctly: ER Delimiter

Example

This example sets the light levels in an F160-LTC20 Intelligent Light as shown in the following diagram.



Input LITPARA 0 77777 Delimiter

Output OK Delimiter

3-2-12 MEASDATA (MD): Measure Data**Function**

Reads the measurement region's measurement results.

Input

MEASDATA <Region number> <Data code> Delimiter

- Specify the desired region (0 to 31) with the region number.
- The data codes depend on the measurement method for the specified region number. Refer to *Data Code Tables (MEASDATA and POSIDATA)* below for details.

Output

Command executed correctly: Measurement result Delimiter
OK Delimiter

Command not executed correctly: ER Delimiter

Example

This example reads the region 0 (gray search) measured Y-coordinate value.

Input MD 0 2 Delimiter

Output 200.000 Delimiter
OK Delimiter

■ **Data Code Tables (MEASDATA and POSIDATA)**

Gravity and Area

Data code	Contents
0	Judgement result (0: OK; -1: NG; -2: Not measured)
1	Gravity position X

Data code	Contents
2	Gravity position Y
3	Area
4	Reversed area
5	Reference position X
6	Reference position Y
7	Reference area
8	Displacement X
9	Displacement Y
10	Diff. area

Gravity and Axis

Data code	Contents
0	Judgement result (0: OK; -1: NG; -2: Not measured)
1	Gravity position X
2	Gravity position Y
3	Axis angle
4	Area
5	Reversed area
6	Reference position X
7	Reference position Y
8	Reference axis angle
9	Reference area
10	Displacement X
11	Displacement Y
12	Diff. axis angle
13	Diff. area

Area (var. box)

This region can be specified with MEASDATA only.

Data code	Contents
0	Judgement result (0: OK; -1: NG; -2: Not measured)
1	Measurement region X1
2	Measurement region Y1
3	Measurement region X2
4	Measurement region Y2
5	Gravity position X
6	Gravity position Y
7	Area
8	Reversed area
9	Reference position X
10	Reference position Y
11	Reference area
12	Displacement X
13	Displacement Y
14	Diff. area

Defect (var. box)

This region can be specified with MEASDATA only.

Data code	Contents
0	Judgement result (0: OK; -1: NG; -2: Not measured)
1	Measurement region X1
2	Measurement region Y1
3	Measurement region X2
4	Measurement region Y2
5	Defect position X
6	Defect position Y
7	Defect level
8	Density max.
9	Density min.
10	Reference position X
11	Reference position Y
12	Displacement X
13	Displacement Y

Edge Pitch

This region can be specified with MEASDATA only.

Data code	Contents
0	Judgement result (0: OK; -1: NG; -2: Not measured)
1	Number of edges
2	Average pitch
3	Max. pitch
4	Min. pitch
5	Average width
6	Max. width
7	Min. width

Defect

This region can be specified with MEASDATA only.

Data code	Contents
0	Judgement result (0: OK; -1: NG; -2: Not measured)
1	Defect level
2	Density max.
3	Density min.
4	Defect position X
5	Defect position Y
6	Reference position X
7	Reference position Y
8	Displacement X
9	Displacement Y

Edge Width

This region can be specified with MEASDATA only.

Data code	Contents
0	Judgement result (0: OK; -1: NG; -2: Not measured)
1	Width
2	Reference width
3	Diff. width

Density Data

This region can be specified with MEASDATA only.

Data code	Contents
0	Judgement result (0: OK; -1: NG; -2: Not measured)
1	Density average
2	Density deviation
3	Standard average
4	Standard deviation
5	Average difference
6	Deviation difference

Edge Position

Data code	Contents
0	Judgement result (0: OK; -1: NG; -2: Not measured)
1	Edge position X
2	Edge position Y
3	Reference position X
4	Reference position Y
5	Displacement X
6	Displacement Y

Gray Search, Precise Search, Flexible Search

The precise search and flexible search can be specified with MEASDATA only.

Data code	Contents
0	Judgement result (0: OK; -1: NG; -2: Not measured)
1	Measurement position X
2	Measurement position Y
3	Correlation
4	Reference position X
5	Reference position Y
6	Displacement X
7	Displacement Y

Classification

This region can be specified with MEASDATA only.

Data code	Contents
0	Judgement result (0: OK; -1: NG; -2: Not measured)
1	Measurement position X
2	Measurement position Y

Data code	Contents
3	Correlation
4	Index number

Labeling

Data code	Contents
0	Judgement result (0: OK; -1: NG; -2: Not measured)
1	Number of labels
2	Measurement position X
3	Measurement position Y
4	Area
5	Reference position X
6	Reference position Y
7	Reference area
8	Displacement X
9	Displacement Y
10	Diff. area

Relative Search

This region can be specified with MEASDATA only.

Data code	Contents
0	Judgement result (0: OK; -1: NG; -2: Not measured)
1	Width X
2	Width Y
3	Distance
4	Correlation (model 0)
5	Correlation (model 1)
6	Reference width X
7	Reference width Y
8	Reference distance
9	Diff. width X
10	Diff. width Y
11	Diff. distance

OCR for One Character

This region can be specified with MEASDATA only.

Data code	Contents
0	Judgement result (0: OK; -1: NG; -2: Not measured)
1	1st candidate (See note.)
2	2nd candidate (See note.)
3	Similarity level
4	Diff. level
5	Density deviation

Note The character is output by its decimal character code.

SeeAlso Refer to the *Expert Menu Operation Manual* for details.

Rotation Search

Data code	Contents
0	Judgement result (0: OK; -1: NG; -2: Not measured)
1	Measurement position X
2	Measurement position Y
3	Measurement angle
4	Correlation
5	Reference position X
6	Reference position Y
7	Reference angle
8	Displacement X
9	Displacement Y
10	Difference angle

3-2-13 MEASPARA (MP): Measure Parameter**Function 1**

Reads the measurement region's parameters.

Input

MEASPARA <Region number> <Data code> Delimiter

- Specify the desired region (0 to 31) with the region number.
- The data codes depend on the measurement method for the specified region number. Refer to *Data Code Tables (MEASPARA and POSIPARA)* below for details.

Output

Command executed correctly: Value Delimiter
OK Delimiter

Command not executed correctly: ER Delimiter

Example

This example reads the region 0 (gray search) Y upper limit. In this case, the Y upper limit is set to 200.000.

Input MP 0 3 Delimiter

Output 200.000 Delimiter
OK Delimiter

Function 2

Sets the measurement region's parameters.

Input

MEASPARA <Region number> <Data code> <New setting> Delimiter

- Specify the desired region (0 to 31) with the region number.
- The data codes depend on the measurement method for the specified region number. Refer to *Data Code Tables (MEASPARA and POSIPARA)* below for details.

Output

Command executed correctly: OK Delimiter

Command not executed correctly: ER Delimiter

Example

This example sets the region 0 (gray search) X lower limit to 400.000.

Input MP 0 2 400.000 Delimiter

Output OK Delimiter

■ **Data Code Tables (MEASPARA and POSIPARA)**

Gravity and Area

Data code	Contents
0	Coordinate mode (0: After scroll, calibration OFF 1: Before scroll, calibration OFF 2: After scroll, calibration ON 3: Before scroll, calibration ON)
1	X upper limit (-9,999.999 to 9,999.999)
2	X lower limit (-9,999.999 to 9,999.999)
3	Y upper limit (-9,999.999 to 9,999.999)
4	Y upper limit (-9,999.999 to 9,999.999)
5	Area upper limit (0.000 to 9,999,999.999)
6	Area lower limit (0.000 to 9,999,999.999)
7	Region's upper left X (0 to 511)
8	Region's upper left Y (0 to 483)
9	Region's lower right X (0 to 511)
10	Region's lower right Y (0 to 483)
11	Binary level upper limit (0 to 255)
12	Binary level upper limit (0 to 255)
13	Binary level reverse (0: Not reversed; 1: Reversed)
14	Skipping X (1 to 15)
15	Skipping Y (1 to 15)
16	Fill profile (0: OFF; 1: ON)
17	Reference position X (0 to 511)
18	Reference position Y (0 to 483)

Gravity and Axis

Data code	Contents
0	Coordinate mode (0: After scroll, calibration OFF 1: Before scroll, calibration OFF 2: After scroll, calibration ON 3: Before scroll, calibration ON)
1	X upper limit (-9,999.999 to 9,999.999)
2	X lower limit (-9,999.999 to 9,999.999)
3	Y upper limit (-9,999.999 to 9,999.999)
4	Y lower limit (-9,999.999 to 9,999.999)
5	Area upper limit (0.000 to 9,999,999.999)
6	Area lower limit (0.000 to 9,999,999.999)
7	Region's upper left X (0 to 511)
8	Region's upper left Y (0 to 483)
9	Region's lower right X (0 to 511)
10	Region's lower right Y (0 to 483)
11	Binary level upper limit (0 to 255)
12	Binary level lower limit (0 to 255)

Data code	Contents
13	Binary level reverse (0: Not reversed; 1: Reversed)
14	Skipping X (1 to 15)
15	Skipping Y (1 to 15)
16	Axis angle upper limit (-180.000 to 180.000)
17	Axis angle lower limit (-180.000 to 180.000)
18	Reference position X (0 to 511)
19	Reference position Y (0 to 483)

Defect

This region can be specified with MEASPARA only.

Data code	Contents
0	Coordinate mode (0: After scroll, calibration OFF 1: Before scroll, calibration OFF 2: After scroll, calibration ON 3: Before scroll, calibration ON)
1	Defect judgement value (0 to 255)
2	Density upper limit (0 to 255)
3	Density lower limit (0 to 255)
4	Element size (4 to 80)
5	Compare pitch (1 to 6)
6	Region's upper left X (arbitrary region: 0 to 511)
7	Region's upper left Y (arbitrary region: 0 to 483)
8	Region's lower right X (arbitrary region: 0 to 511)
9	Region's lower right Y (arbitrary region: 0 to 483)
10	Start point X (line: 0 to 511)
11	Start point Y (line: 0 to 483)
12	End point X (line: 0 to 511)
13	End point Y (line: 0 to 483)
14	Width (line: 1 to 64)
15	Center X (circumference: 0 to 511)
16	Center Y (circumference: 0 to 483)
17	Radius (circumference: 1 to 512; see note.)
18	Width (circumference: 1 to 64)
19	Center X (arc: 0 to 511)
20	Center Y (arc: 0 to 483)
21	Radius (arc: 1 to 512; see note.)
22	Width (arc: 1 to 64)
23	Start angle (arc: -180.00 to 180.00)
24	End angle (arc: -180.00 to 180.00)
25	Reference position X (0 to 511)
26	Reference position Y (0 to 483)

Note Depending on the circle's center coordinates and element size settings, it may not be possible to set some values because they are too small or too large.

Area (var. box)

This region can be specified with MEASPARA only.

Data code	Contents
0	Coordinate mode (0: After scroll, calibration OFF 1: Before scroll, calibration OFF 2: After scroll, calibration ON 3: Before scroll, calibration ON)
1	X upper limit (-9,999.999 to 9,999.999)
2	X lower limit (-9,999.999 to 9,999.999)
3	Y upper limit (-9,999.999 to 9,999.999)
4	Y lower limit (-9,999.999 to 9,999.999)
5	Area upper limit (0.000 to 9,999,999.999)
6	Area lower limit (0.000 to 9,999,999.999)
7	Binary level upper limit (0 to 255)
8	Binary level lower limit (0 to 255)
9	Binary level reverse (0: Not reversed; 1: Reversed)
10	Skipping X (1 to 15)
11	Skipping Y (1 to 15)
12	Fill profile (0: OFF; 1: ON)
13	Edge search direction (Left edge: Up=0, Down=1, Right=2, Left=3)
14	Edge color (Left edge: Light-to-dark=0, Dark-to-light=1)
15	Edge level (Left edge: 0 to 100)
16	Noise level (Left edge: 0 to 255)
17	Noise width (Left edge: 0 to 255)
18	Offset width (Left edge: -511 to 511)
19	Edge search direction (Upper edge: Up=0, Down=1, Right=2, Left=3)
20	Edge color (Upper edge: Light-to-dark=0, Dark-to-light=1)
21	Edge level (Upper edge: 0 to 100)
22	Noise level (Upper edge: 0 to 255)
23	Noise width (Upper edge: 0 to 255)
24	Offset width (Upper edge: -511 to 511)
25	Edge search direction (Right edge: Up=0, Down=1, Right=2, Left=3)
26	Edge color (Right edge: Light-to-dark=0, Dark-to-light=1)
27	Edge level (Right edge: 0 to 100)
28	Noise level (Right edge: 0 to 255)
29	Noise width (Right edge: 0 to 255)
30	Offset width (Right edge: -511 to 511)
31	Edge search direction (Lower edge: Up=0, Down=1, Right=2, Left=3)
32	Edge color (Lower edge: Light-to-dark=0, Dark-to-light=1)
33	Edge level (Lower edge: 0 to 100)
34	Noise level (Lower edge: 0 to 255)
35	Noise width (Lower edge: 0 to 255)
36	Offset width (Lower edge: -511 to 511)

Data code	Contents
37	Region's upper left X (Left edge: 0 to 511)
38	Region's upper left Y (Left edge: 0 to 483)
39	Region's lower right X (Left edge: 0 to 511)
40	Region's lower right Y (Left edge: 0 to 483)
41	Region's upper left X (Upper edge: 0 to 511)
42	Region's upper left Y (Upper edge: 0 to 483)
43	Region's lower right X (Upper edge: 0 to 511)
44	Region's lower right Y (Upper edge: 0 to 483)
45	Region's upper left X (Right edge: 0 to 511)
46	Region's upper left Y (Right edge: 0 to 483)
47	Region's lower right X (Right edge: 0 to 511)
48	Region's lower right Y (Right edge: 0 to 483)
49	Region's upper left X (Lower edge: 0 to 511)
50	Region's upper left Y (Lower edge: 0 to 483)
51	Region's lower right X (Lower edge: 0 to 511)
52	Region's lower right Y (Lower edge: 0 to 483)
53	Reference position X (0 to 511)
54	Reference position Y (0 to 483)

Edge Position

Data code	Contents
0	Coordinate mode (0: After scroll, calibration OFF 1: Before scroll, calibration OFF 2: After scroll, calibration ON 3: Before scroll, calibration ON)
1	X upper limit (-9,999.999 to 9,999.999)
2	X lower limit (-9,999.999 to 9,999.999)
3	Y upper limit (-9,999.999 to 9,999.999)
4	Y lower limit (-9,999.999 to 9,999.999)
5	Region's upper left X (0 to 511)
6	Region's upper left Y (0 to 483)
7	Region's lower right X (0 to 511)
8	Region's lower right Y (0 to 483)
9	Edge search direction (Up=0, Down=1, Right=2, Left=3)
10	Edge color (Light-to-dark=0, Dark-to-light=1)
11	Edge level (0 to 100)
12	Noise level (0 to 255)
13	Noise width (0 to 255)
14	Reference position X (0 to 511)
15	Reference position Y (0 to 483)

Defect (var. box)

This region can be specified with MEASPARA only.

Data code	Contents
0	Coordinate mode (0: After scroll, calibration OFF 1: Before scroll, calibration OFF 2: After scroll, calibration ON 3: Before scroll, calibration ON)
1	Defect judgement value (0 to 255)
2	Density upper limit (0 to 255)
3	Density lower limit (0 to 255)
4	Element size (4 to 80)
5	Compare pitch (1 to 6)
6	Measure direction (0: X, 1: Y, 2: Box)
7	Edge search direction (Left edge: Up=0, Down=1, Right=2, Left=3)
8	Edge color (Left edge: Light-to-dark=0, Dark-to-light=1)
9	Edge level (Left edge: 0 to 100)
10	Noise level (Left edge: 0 to 255)
11	Noise width (Left edge: 0 to 255)
12	Offset width (Left edge: -511 to 511)
13	Edge search direction (Upper edge: Up=0, Down=1, Right=2, Left=3)
14	Edge color (Upper edge: Light-to-dark=0, Dark-to-light=1)
15	Edge level (Upper edge: 0 to 100)
16	Noise level (Upper edge: 0 to 255)
17	Noise width (Upper edge: 0 to 255)
18	Offset width (Upper edge: -511 to 511)
19	Edge search direction (Right edge: Up=0, Down=1, Right=2, Left=3)
20	Edge color (Right edge: Light-to-dark=0, Dark-to-light=1)
21	Edge level (Right edge: 0 to 100)
22	Noise level (Right edge: 0 to 255)
23	Noise width (Right edge: 0 to 255)
24	Offset width (Right edge: -511 to 511)
25	Edge search direction (Lower edge: Up=0, Down=1, Right=2, Left=3)
26	Edge color (Lower edge: Light-to-dark=0, Dark-to-light=1)
27	Edge level (Lower edge: 0 to 100)
28	Noise level (Lower edge: 0 to 255)
29	Noise width (Lower edge: 0 to 255)
30	Offset width (Lower edge: -511 to 511)
31	Region's upper left X (Left edge: 0 to 511)
32	Region's upper left Y (Left edge: 0 to 483)
33	Region's lower right X (Left edge: 0 to 511)
34	Region's lower right Y (Left edge: 0 to 483)
35	Region's upper left X (Upper edge: 0 to 511)
36	Region's upper left Y (Upper edge: 0 to 483)

Data code	Contents
37	Region's lower right X (Upper edge: 0 to 511)
38	Region's lower right Y (Upper edge: 0 to 483)
39	Region's upper left X (Right edge: 0 to 511)
40	Region's upper left Y (Right edge: 0 to 483)
41	Region's lower right X (Right edge: 0 to 511)
42	Region's lower right Y (Right edge: 0 to 483)
43	Region's upper left X (Lower edge: 0 to 511)
44	Region's upper left Y (Lower edge: 0 to 483)
45	Region's lower right X (Lower edge: 0 to 511)
46	Region's lower right Y (Lower edge: 0 to 483)
47	Reference position X (0 to 511)
48	Reference position Y (0 to 483)

Edge Width

This region can be specified with MEASPARA only.

Data code	Contents
0	Coordinate mode (0: Calibration OFF 1: Calibration ON)
1	Edge width upper limit (0 to 9,999.999)
2	Edge width lower limit (0 to 9,999.999)
3	Edge search direction (Edge 1: Up=0, Down=1, Right=2, Left=3)
4	Edge color (Edge 1: Light-to-dark=0, Dark-to-light=1)
5	Edge level (Edge 1: 0 to 100)
6	Noise level (Edge 1: 0 to 255)
7	Noise width (Edge 1: 0 to 255)
8	Edge search direction (Edge 2: Up=0, Down=1, Right=2, Left=3)
9	Edge color (Edge 2: Light-to-dark=0, Dark-to-light=1)
10	Edge level (Edge 2: 0 to 100)
11	Noise level (Edge 2: 0 to 255)
12	Noise width (Edge 2: 0 to 255)
13	Upper left X (0 to 511)
14	Upper left Y (0 to 483)
15	Lower right X (0 to 511)
16	Lower right Y (0 to 483)
17	Reference position X1 (0 to 511)
18	Reference position Y1 (0 to 483)
19	Reference position X2 (0 to 511)
20	Reference position Y2 (0 to 483)

Edge Pitch

This region can be specified with MEASPARA only.

Data code	Contents
0	Coordinate mode (0: Calibration OFF 1: Calibration ON)
1	Number of edges upper limit (0 to 255)
2	Number of edges lower limit (0 to 255)
3	Pitch upper limit (0 to 9,999.999)
4	Pitch lower limit (0 to 9,999.999)
5	Width upper limit (0 to 9,999.999)
6	Width lower limit (0 to 9,999.999)
7	Region's upper left X (0 to 511)
8	Region's upper left Y (0 to 483)
9	Region's lower right X (0 to 511)
10	Region's lower right Y (0 to 483)
11	Count target color (White: 0, Black: 1)
12	Edge level (0 to 100)
13	Minimum level (0 to 255)
14	Mode (0: Coordinate, 1: Fine)

Density Data

This region can be specified with MEASPARA only.

Data code	Contents
0	Density average upper limit (0 to 255.000)
1	Density average lower limit (0 to 255.000)
2	Density deviation upper limit (0 to 127.000)
3	Density deviation lower limit (0 to 127.000)
4	Region's upper left X (0 to 511)
5	Region's upper left Y (0 to 483)
6	Region's lower right X (0 to 511)
7	Region's lower right Y (0 to 483)

Precise Search

This region can be specified with MEASPARA only.

Data code	Contents
0	Coordinate mode (0: After scroll, calibration OFF 1: Before scroll, calibration OFF 2: After scroll, calibration ON 3: Before scroll, calibration ON)
1	X upper limit (-9,999.999 to 9,999.999)
2	X lower limit (-9,999.999 to 9,999.999)
3	Y upper limit (-9,999.999 to 9,999.999)
4	Y lower limit (-9,999.999 to 9,999.999)
5	Correlation upper limit (0 to 100)
6	Correlation lower limit (0 to 100)
7	Search region's upper left X (0 to 511)
8	Search region's upper left Y (0 to 483)

Data code	Contents
9	Search region's lower right X (0 to 511)
10	Search region's lower right Y (0 to 483)
11	Model registration region's upper left X (0 to 511)
12	Model registration region's upper left Y (0 to 483)
13	Model registration region's upper left Y (0 to 511)
14	Model registration region's lower right Y (0 to 483)
15	Model reference position X (0 to 511)
16	Model reference position Y (0 to 483)
17	Candidate level (0 to 100)
18	Model skipping setting (0: Auto, 1: Fixed)
19	Model skipping X (1 to 15)
20	Model skipping Y (1 to 15)
21	Search skipping setting (0: Auto, 1: Fixed)
22	Search skipping X (1 to 15)
23	Search skipping Y (1 to 15)

Gray Search

Data code	Contents
0	Coordinate mode (0: After scroll, calibration OFF 1: Before scroll, calibration OFF 2: After scroll, calibration ON 3: Before scroll, calibration ON)
1	X upper limit (-9,999.999 to 9,999.999)
2	X lower limit (-9,999.999 to 9,999.999)
3	Y upper limit (-9,999.999 to 9,999.999)
4	Y lower limit (-9,999.999 to 9,999.999)
5	Correlation upper limit (0 to 100)
6	Correlation lower limit (0 to 100)
7	Search region's upper left X (0 to 511)
8	Search region's upper left Y (0 to 483)
9	Search region's lower right X (0 to 511)
10	Search region's lower right Y (0 to 483)
11	Model registration region's upper left X (0 to 511)
12	Model registration region's upper left Y (0 to 483)
13	Model registration region's lower right X (0 to 511)
14	Model registration region's lower right Y (0 to 483)
15	Model reference position X (0 to 511)
16	Model reference position Y (0 to 483)
17	Candidate level (0 to 100)
18	Model skipping setting (0: Auto, 1: Fixed)
19	Model skipping X (1 to 15)
20	Model skipping Y (1 to 15)
21	Search skipping setting (0: Auto, 1: Fixed)
22	Search skipping X (1 to 15)
23	Search skipping Y (1 to 15)
24	Model skipping setting (0: Auto, 1: Fixed)
25	Detailed model skipping X (1 to 15)
26	Detailed model skipping X (1 to 15)

Rotation Search

Data code	Contents
0	Coordinate mode (0: After scroll, calibration OFF 1: Before scroll, calibration OFF 2: After scroll, calibration ON 3: Before scroll, calibration ON)
1	X upper limit (-9,999.999 to 9,999.999)
2	X lower limit (-9,999.999 to 9,999.999)
3	Y upper limit (-9,999.999 to 9,999.999)
4	Y lower limit (-9,999.999 to 9,999.999)
5	Correlation upper limit (0 to 100)
6	Correlation lower limit (0 to 100)
7	Angle upper limit (-360 to 360)
8	Angle lower limit (-360 to 360)
9	Search region's upper left X (0 to 511)
10	Search region's upper left Y (0 to 483)
11	Search region's lower right X (0 to 511)
12	Search region's lower right Y (0 to 483)
13	Model registration region's upper left X (0 to 511)
14	Model registration region's upper left Y (0 to 483)
15	Model registration region's lower right X (0 to 511)
16	Model registration region's lower right Y (0 to 483)
17	Model reference position X (0 to 511)
18	Model reference position Y (0 to 483)
19	Skipping angle (1 to 99)
20	Rotation range upper limit (-360 to 360)
21	Rotation range lower limit (-360 to 360)
22	Angle compensation (0: None, 1: Enabled)
23	Candidate level (0 to 100)
24	Model skipping setting (0: Auto, 1: Fixed)
25	Model skipping X (1 to 15)
26	Model skipping Y (1 to 15)
27	Search skipping setting (0: Auto, 1: Fixed)
28	Search skipping X (1 to 15)
29	Search skipping Y (1 to 15)
30	Detailed model skipping setting (0: Auto, 1: Fixed)
31	Detailed model skipping X (1 to 15)
32	Detailed model skipping Y (1 to 15)

Flexible Search and Classification

This region can be specified with MEASPARA only.

Data code	Contents
0	Coordinate mode (0: After scroll, calibration OFF 1: Before scroll, calibration OFF 2: After scroll, calibration ON 3: Before scroll, calibration ON)
1	X upper limit (-9,999.999 to 9,999.999)
2	X lower limit (-9,999.999 to 9,999.999)
3	Y upper limit (-9,999.999 to 9,999.999)

Data code	Contents
4	Y lower limit (-9,999.999 to 9,999.999)
5	Correlation upper limit (0 to 100)
6	Correlation lower limit (0 to 100)
7	Search region's upper left X (0 to 511)
8	Search region's upper left Y (0 to 483)
9	Search region's lower right X (0 to 511)
10	Search region's lower right Y (0 to 483)
11	Interpolation (0: OFF, 1: ON)
12	Candidate level (0 to 100)
13	Model skipping setting (0: Auto, 1: Fixed)
14	Model skipping X (1 to 15)
15	Model skipping Y (1 to 15)
16	Search skipping setting (0: Auto, 1: Fixed)
17	Search skipping X (1 to 15)
18	Search skipping Y (1 to 15)
19	Detailed model skipping setting (0: Auto, 1: Fixed)
20	Detailed model skipping X (1 to 15)
21	Detailed model skipping Y (1 to 15)

OCR for One Character

This region can be specified with MEASPARA only.

Data code	Contents
0	Measurement region's upper left X (0 to 511)
1	Measurement region's upper left Y (0 to 483)
2	Measurement region's lower right X (0 to 511)
3	Measurement region's lower right Y (0 to 483)
4	Character color (0: Black, 1: White)
5	Object (0: Standard, 1: Dot character)
6	Alphabetical characters (0: OFF 1: ON)
7	Numerical characters (0: OFF 1: ON)
8	Symbols (0: OFF 1: ON)
9	Unpattern (0: OFF 1: ON)
10	Similarity level (1 to 100)
11	Diff. level (0 to 100)
12	Density deviation (0 to 127)

Relative Search

This region can be specified with MEASPARA only.

Data code	Contents
0	Coordinate mode (0: After scroll, calibration OFF 1: Before scroll, calibration OFF 2: After scroll, calibration ON 3: Before scroll, calibration ON)
1	Width X upper limit (-9,999.999 to 9,999.999)
2	Width X lower limit (-9,999.999 to 9,999.999)
3	Width Y upper limit (-9,999.999 to 9,999.999)
4	Width Y lower limit (-9,999.999 to 9,999.999)

Data code	Contents
5	Distance upper limit (0 to 9,999.999)
6	Distance lower limit (0 to 9,999.999)
7	Correlation 0 upper limit (0 to 100)
8	Correlation 0 lower limit (0 to 100)
9	Search region 0 upper left X (0 to 511)
10	Search region 0 upper left Y (0 to 483)
11	Search region 0 lower right X (0 to 511)
12	Search region 0 lower right Y (0 to 483)
13	Model 0 registration region's upper left X (0 to 511)
14	Model 0 registration region's upper left Y (0 to 483)
15	Model 0 registration region's lower right X (0 to 511)
16	Model 0 registration region's lower right Y (0 to 483)
17	Model 0 reference position X (0 to 511)
18	Model 0 reference position Y (0 to 483)
19	Candidate 0 level (0 to 100)
20	Model 0 skipping setting (0: Auto, 1: Fixed)
21	Model 0 skipping X (1 to 15)
22	Model 0 skipping Y (1 to 15)
23	Search 0 skipping setting (0: Auto, 1: Fixed)
24	Search 0 skipping X (1 to 15)
25	Search 0 skipping Y (1 to 15)
26	Correlation 1 upper limit (0 to 100)
27	Correlation 1 lower limit (0 to 100)
28	Search region 1 upper left X (0 to 511)
29	Search region 1 upper left Y (0 to 483)
30	Search region 1 lower right X (0 to 511)
31	Search region 1 lower right Y (0 to 483)
32	Model 1 registration region's upper left X (0 to 511)
33	Model 1 registration region's upper left Y (0 to 483)
34	Model 1 registration region's lower right X (0 to 511)
35	Model 1 registration region's lower right Y (0 to 483)
36	Model 1 reference position X (0 to 511)
37	Model 1 reference position Y (0 to 483)
38	Candidate 1 level (0 to 100)
39	Model 1 skipping setting (0: Auto, 1: Fixed)
40	Model 1 skipping X (1 to 15)
41	Model 1 skipping Y (1 to 15)
42	Search 1 skipping setting (0: Auto, 1: Fixed)
43	Search 1 skipping X (1 to 15)
44	Search 1 skipping Y (1 to 15)

Labeling

This region can be specified with MEASPARA only.

Data code	Contents
0	Coordinate mode (0: After scroll, calibration OFF 1: Before scroll, calibration OFF 2: After scroll, calibration ON 3: Before scroll, calibration ON)
1	Measurement region's upper left X (0 to 511)
2	Measurement region's upper left Y (0 to 483)
3	Measurement region's lower right X (0 to 511)
4	Measurement region's lower right Y (0 to 483)
5	Binary level upper limit (0 to 255)
6	Binary level lower limit (0 to 255)
7	Binary level reverse (0: Not reversed, 1: Reversed)
8	Area upper limit (0 to 9,999,999.999)
9	Area lower limit (0 to 9,999,999.999)
10	Hole filling (0: OFF, 1: ON)
11	Sort mode (0: Area descending order, 1: Area ascending order, 2: X gravity descending order, 3: X gravity ascending order, 4: Y gravity descending order, 5: Y gravity ascending order)
12	Outside trimming (0: OFF, 1: ON)
13	Label number (0 to 2,499)
14	Number of labels judgement upper limit (0 to 2,500)
15	Number of labels judgement lower limit (0 to 2,500)
16	Area judgement upper limit (0 to 9,999,999.999)
17	Area judgement lower limit (0 to 9,999,999.999)
18	Gravity X upper limit (-9,999.999 to 9,999.999)
19	Gravity X lower limit (-9,999.999 to 9,999.999)
20	Gravity Y upper limit (-9,999.999 to 9,999.999)
21	Gravity Y lower limit (-9,999.999 to 9,999.999)

3-2-14 MEASURE (M)**Function 1**

Executes one measurement.

Input

MEASURE Delimiter

Output

Command executed correctly: Measurement result Delimiter
OK Delimiter

Command not executed correctly: ER Delimiter

SeeAlso See page 61 for details on measurement results.

Function 2

Executes one measurement on the image being displayed.

Input

MEASURE /I Delimiter

Output

Command executed correctly: Measurement result Delimiter
OK Delimiter
Command not executed correctly: ER Delimiter

SeeAlso See page 61 for details on measurement results.

Function 3

Starts continuous measurement.

Input

MEASURE /C Delimiter

Output

Command executed correctly: OK Delimiter (One time)
Measurement result Delimiter (Continuous measurement of the specified number of repetitions)
Command not executed correctly: ER Delimiter

SeeAlso See page 61 for details on measurement results.

Function 4

Stops continuous measurement.

Input

MEASURE /E Delimiter

Output

Command executed correctly: OK Delimiter
Command not executed correctly: ER Delimiter

3-2-15 MENUKEY**Function**

Switches the serial interface input to Menu Operation mode.

Input

MENUKEY Delimiter

Output

None

CHECK The F160 will revert to Normal mode if the **Ctrl + Q** Key combination (\$11) is input while the F160 is in Menu Operation mode.

3-2-16 MODELSET**Function**

Registers the model again based on the image being displayed. (When the through display is being used, the model will be registered based on the last image that was measured.)

Input

MODELSET <Region number> Delimiter

Specify the desired region (0 to 31) with the region number.
The specified number is valid only if it is a Gray Search, Precise Search, Rotation Search, or Relative Search region number.

Output

Command executed correctly: OK Delimiter
Command not executed correctly: ER Delimiter

Example 1

This example re-registers the region 2 (Gray Search) model.

Input MODELSET 2 Delimiter
Output OK Delimiter

CHECK

If a region number other than a Gray Search, Precise Search, Rotation Search, or Relative Search region number is specified, the command will be ignored but OK will be output.

Example 2

In this example, the region 1 (Gravity and Area) model is specified. No settings are made in this case.

Input MODELSET 1 Delimiter
Output OK Delimiter

TwoCamera

The model registration is performed using the camera image that is currently being displayed, so execute the MODELSET command after switching to the camera image for the region that you want to register again. Switch the camera image by pressing the Up and Down Arrow Keys on the Console. If the MENUKEY command is executed, the key codes corresponding to the Console's Up and Down Arrow Keys can be input from a personal computer.

SeeAlso

Refer to page 51 for details on the MENUKEY command.

3-2-17 PASSWORD**Function**

Reads the password.

Input

PASSWORD Delimiter

Output

Command executed correctly: Password data Delimiter
OK Delimiter
Command not executed correctly: ER Delimiter

Example

In this example, the password is set to AAAAAAA.

Input PASSWORD Delimiter
Output AAAAAAA Delimiter
OK Delimiter

3-2-18 POSIAMNT: Position Amount**Function**

Reads the position compensation amount.

Input

POSIAMNT <parameter 1> <parameter 2> Delimiter

- The parameter 1 settings are as follows:

Setting	Contents
0	Camera 0 first direction
1	Camera 0 second direction
2	Camera 1 third direction
3	Camera 1 fourth direction

- The parameter 2 settings are as follows:

Setting	Contents
0	X-direction compensation
1	Y-direction compensation
2	Angular compensation

Output

Command executed correctly: Value Delimiter
OK Delimiter

Command not executed correctly: ER Delimiter

Example

This example reads the angular compensation for the “camera 0 first direction.” In this case, the angular compensation is 30.000.

Input POSIAMNT 0 2 Delimiter

Output 30.000 Delimiter
OK Delimiter

3-2-19 POSIDATA (PD): Position Data

Function

Reads the position compensation region's measurement results.

Input

POSIDATA <region number> <data code> Delimiter

- Specify a region number between 0 and 7.
- The data codes depend on the position compensation method for the specified region number. The data codes are the same as the ones used for the MEASDATA command.

SeeAlso Refer to *Data Code Tables (MEASDATA and POSIDATA)* on page 33 for details.

Output

Command executed correctly: Compensation amount Delimiter
OK Delimiter

Command not executed correctly: ER Delimiter

Example

This example reads the Y-coordinate measurement for position compensation region 0 (Gray Search). In this case, the Y-coordinate's measurement is 200.000.

Input PD 0 2 Delimiter

Output 200.000 Delimiter
OK Delimiter

3-2-20 POSIPARA (PP): Position Parameter

Function 1

Reads the position compensation region's parameters.

Input

POSIPARA <region number> <data code> Delimiter

- Specify a region number between 0 and 7.
- The data codes depend on the position compensation method for the specified region number. The data codes are the same as the ones used for the MEASPARA command.

SeeAlso

Refer to *Data Code Tables (MEASPARA and POSIPARA)* on page 39 for details.

Output

Command executed correctly: Value Delimiter
OK Delimiter

Command not executed correctly: ER Delimiter

Example

This example reads the Y upper limit for position compensation region 0 (Gray Search). In this case, the Y upper limit is 200.000.

Input PP 0 3 Delimiter

Output 200.000 Delimiter
OK Delimiter

Function 2

Sets the position compensation region's parameters.

Input

POSIPARA <region number> <data code> <new setting> Delimiter

- Specify a region number between 0 and 7.
- The data codes depend on the position compensation method for the specified region number. The data codes are the same as the ones used for the MEASPARA command.

SeeAlso

Refer to *Data Code Tables (MEASPARA and POSIPARA)* on page 39 for details.

Output

Command executed correctly: OK Delimiter

Command not executed correctly: ER Delimiter

Example

This example changes the X lower limit for position compensation region 0 (Gray Search) to 400.000.

Input PP 0 2 400 Delimiter

Output OK Delimiter

Output

Command executed correctly: OK Delimiter
 Command not executed correctly: ER Delimiter

CHECK The data transfer is performed with XMODEM (-CRC or SUM) or ZMODEM protocol. (The XMODEM (-1K) protocol is not supported.)
 The F160 sends the character string "READY" to the external device when the F160 has completed its initialization. Wait for the "READY" string to be received at the external device before starting the data transfer.

Example

This example loads scene data from the external device to scene 2.

Input SCNLOAD 2 Delimiter

Output OK Delimiter

3-2-24 SCNLOADM: Scene Load Memory Card**Function**

Loads scene data from a Memory Card.

Input

SCNLOADM <scene number> <file name> Delimiter

- Specify a scene number between 0 and 31.
- Add the filename extension .SCN to the filename.
- Specify the absolute path from the root directory.

Output

Command executed correctly: OK Delimiter
 Command not executed correctly: ER Delimiter

Example

This example loads the file "LABEL.SCN" to scene 2 from Memory Card slot directory DIR01.

Input SCNLOADM 2 /C0/DIR01/LABEL.SCN Delimiter

Output OK Delimiter

3-2-25 SCNSAVE: Scene Save**Function**

Saves scene data to an external device.

Input

For XMODEM transfers: SCNSAVE <scene number> Delimiter

For ZMODEM transfers: SCNSAVE <scene number> <Filename> Delimiter

Specify a scene number between 0 and 31.

Output

Command executed correctly: OK Delimiter
 Command not executed correctly: ER Delimiter

CHECK The data transfer is performed with XMODEM (-CRC or SUM) or ZMODEM protocol. (The XMODEM (-1K) protocol is not supported.)
 The Controller sends the character string "READY" to the external device when the Controller has completed preparations.

Wait for the "READY" string to be received at the external device before starting the data transfer.

Example

This example saves the scene 2 scene data to the external device.

Input SCNSAVE 2 Delimiter

Output OK Delimiter

3-2-26 SCNSAVEM: Scene Save Memory Card**Function**

Saves scene data to a Memory Card.

Input

SCNSAVEM <scene number> <file name> Delimiter

- Specify a scene number between 0 and 31.
- Add the filename extension .SCN to the filename.
- Specify the absolute path from the root directory.

Output

Command executed correctly: OK Delimiter

Command not executed correctly: ER Delimiter

Example

This example saves the scene 2 scene data as file "LABEL.SCN" in Memory Card slot directory DIR01.

Input SCNSAVEM 2 /C0/DIR01/LABEL.SCN Delimiter

Output OK Delimiter

3-2-27 SCNGROUP: Scene Group**Function 1**

Reads the scene group number being used.

Input

SCNGROUP Delimiter

Output

Command executed correctly: Scene group number Delimiter

OK Delimiter

Command not executed correctly: ER Delimiter

Example

In this example, scene group 0 is being used.

Input SCNGROUP Delimiter

Output 0 Delimiter
OK Delimiter

Function 2

Switches the scene group number.

Input

SCNGROUP <scene group number> Delimiter

Specify a scene group number between 0 and 31.

Output

Command executed correctly: OK Delimiter
Command not executed correctly: ER Delimiter

Example

This example switches to scene group 2.

Input SCNGROUP 2 Delimiter
Output OK Delimiter

3-2-28 SGRLOAD: Scene Group Load**Function**

Loads scene group data from an external device.

Input

SGRLOAD <scene group number> Delimiter
Specify a scene group number between 0 and 31.

Output

Command executed correctly: OK Delimiter
Command not executed correctly: ER Delimiter

CHECK

The data transfer is performed with XMODEM (-CRC or SUM) or ZMODEM protocol. (The XMODEM (-1K) protocol is not supported.) The F160 sends the character string "READY" to the external device when the F160 has completed its initialization. Wait for the "READY" string to be received at the external device before starting the data transfer.

Example

This example loads the scene group data from the external device to scene group 2.

Input SGRLOAD 2 Delimiter
Output OK Delimiter

3-2-29 SGRLOADM: Scene Group Load Memory Card**Function**

Loads scene group data from a Memory Card.

Input

SGRLOADM <scene group number> <file name> Delimiter

- Specify a scene group number between 0 and 31.
- Add the filename extension .SGR to the filename.
- Specify the absolute path from the root directory.

Output

Command executed correctly: OK Delimiter
Command not executed correctly: ER Delimiter

Example

This example loads the file "LABEL.SGR" to scene group 2 from Memory Card slot directory DIR01.

Input SGRLOADM 2 /C0/DIR01/LABEL.SGR Delimiter
Output OK Delimiter

3-2-30 SGRSAVE: Scene Group Save

Function

Saves scene group data to an external device.

Input

For XMODEM transfers: SGRSAVE <scene group number> Delimiter

For ZMODEM transfers: SGRSAVE <scene group number> <Filename>
Delimiter

Specify a scene group number between 0 and 31.

Output

Command executed correctly: OK Delimiter

Command not executed correctly: ER Delimiter

CHECK

The data transfer is performed with XMODEM (-CRC or SUM) or ZMODEM protocol. (The XMODEM (-1K) protocol is not supported.)

Example

This example saves the scene group data of scene group 2 to the external device.

Input SGRSAVE 2 Delimiter

Output OK Delimiter

3-2-31 SGRSAVEM: Scene Group Save Memory Card

Function

Saves scene group data to a Memory Card.

Input

SGRSAVEM <scene group number> <file name> Delimiter

- Specify a scene group number between 0 and 31.
- Add the filename extension .SGR to the filename.
- Specify the absolute path from the root directory.

Output

Command executed correctly: OK Delimiter

Command not executed correctly: ER Delimiter

Example

This example saves the scene group data of scene group 2 as file "LABEL.SGR" in Memory Card slot directory DIR01.

Input SGRSAVEM 2 /C0/DIR01/LABEL.SGR Delimiter

Output OK Delimiter

3-2-32 SYSLOAD: System Load

Function

Loads system data from an external device.

Input

SYSLOAD Delimiter

Output

Command executed correctly: OK Delimiter
 Command not executed correctly: ER Delimiter

CHECK The data transfer is performed with XMODEM (-CRC or SUM) or ZMODEM protocol. (The XMODEM (-1K) protocol is not supported.)
 The F160 sends the character string "READY" to the external device when the F160 has completed its initialization. Wait for the "READY" string to be received at the external device before starting the data transfer.

Example

This example loads the system data from the external device.

Input SYSLOAD Delimiter
 Output OK Delimiter

3-2-33 SYSLOADM: System Load Memory Card**Function**

Loads system data from a Memory Card.

Input

SYSLOADM <file name> Delimiter

- Add the filename extension .SYD to the filename.
- Specify the absolute path from the root directory.

Output

Command executed correctly: OK Delimiter
 Command not executed correctly: ER Delimiter

Example

This example loads the file "SYSDAT1.SYD" from Memory Card slot directory DIR01.

Input SYSLOADM /C0/DIR01/SYSDAT1.SYD Delimiter
 Output OK Delimiter

3-2-34 SYSSAVE: System Save**Function**

Saves system data to an external device.

Input

For XMODEM transfers: SYSSAVE Delimiter
 For ZMODEM transfers: SYSSAVE <Filename> Delimiter

Output

Command executed correctly: OK Delimiter
 Command not executed correctly: ER Delimiter

CHECK The data transfer is performed with XMODEM (-CRC or SUM) or ZMODEM protocol. (The XMODEM (-1K) protocol is not supported.)
 The Controller sends the character string "READY" to the external device when the Controller has completed preparations.
 Wait for the "READY" string to be received at the external device before starting the data transfer.

Example

This example saves the system data to the external device.

Input SYSSAVE Delimiter

Output OK Delimiter

3-2-35 SYSSAVEM: System Save Memory Card**Function**

Saves system data to a Memory Card.

Input

SYSSAVEM <file name> Delimiter

- Add the filename extension .SYD to the filename.
- Specify the absolute path from the root directory.

Output

Command executed correctly: OK Delimiter

Command not executed correctly: ER Delimiter

Example

This example saves the system data as the file "SYSDAT1.SYD" in Memory Card slot directory DIR01.

Input SYSSAVEM /C0/DIR01/SYSDAT1.SYD Delimiter

Output OK Delimiter

3-2-36 VERGET: Version Get**Function**

Reads the system's version information.

Input

VERGET Delimiter

Output

Command executed correctly: OK Delimiter

Command not executed correctly: ER Delimiter

Example

System version information is read.

In this example, the Controller is a model F160-C10, the software version is 1.00, and the creation date is 11/1/2000 at 12 noon.

Input VERGET Delimiter

Output F160-C10 Ver1.00 2000/11/01 12:00
OK Delimiter

3-3 Output Format (Normal)

The measurement results are output by output number in ascending order. Measurement results are output using normal communications when the communications mode is set to menu operation.

<Data 0 measurement> , <Data 1 measurement> , - - -
<Data 30 measurement> , <Data 31 measurement> Delimiter

SECTION 4

Host Link Serial Interface

This section explains how to use the F160's serial interface to communicate with an external device such as a programmable controller (PLC).

4-1	Setting Communications Specifications	64
4-1-1	Operational Flowcharts	65
4-1-2	F160 Settings	67
4-2	Input Format (Host Link)	70
4-3	Output Format (Host Link)	81
4-4	Sample Ladder Program	83

4-1 Setting Communications Specifications

If the communications mode is set to **Host link**, the F160 can communicate with a host device such as a programmable controller (PLC) through its serial interface using the host link protocol.

CHECK Only a 1:1 connection can be made with host link; the F160's host link does not support 1:N connections.

SeeAlso Refer to page 19 for details.

- **Setting Mode**
Command inputs are not received.
- **Monitor Mode**
Command inputs are received, but the measurement results are not output to external devices.
When a command is input to read a set value, the appropriate value will be output.
- **Run Mode**
Command inputs are received and measurement results are output.

CHECK After measurements have been made in Run Mode, the data up through the last measurement will be output even if the mode is changed to another mode. The data output will not be interrupted midway.

4-1-1 Operational Flowcharts

Serial Interface with I/O

Set the commands in the read bits of the Programmable Controller. The F160 will read the commands directly from the read bits.

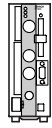

F160



Programmable Controller
(Unit number: 00 (fixed))

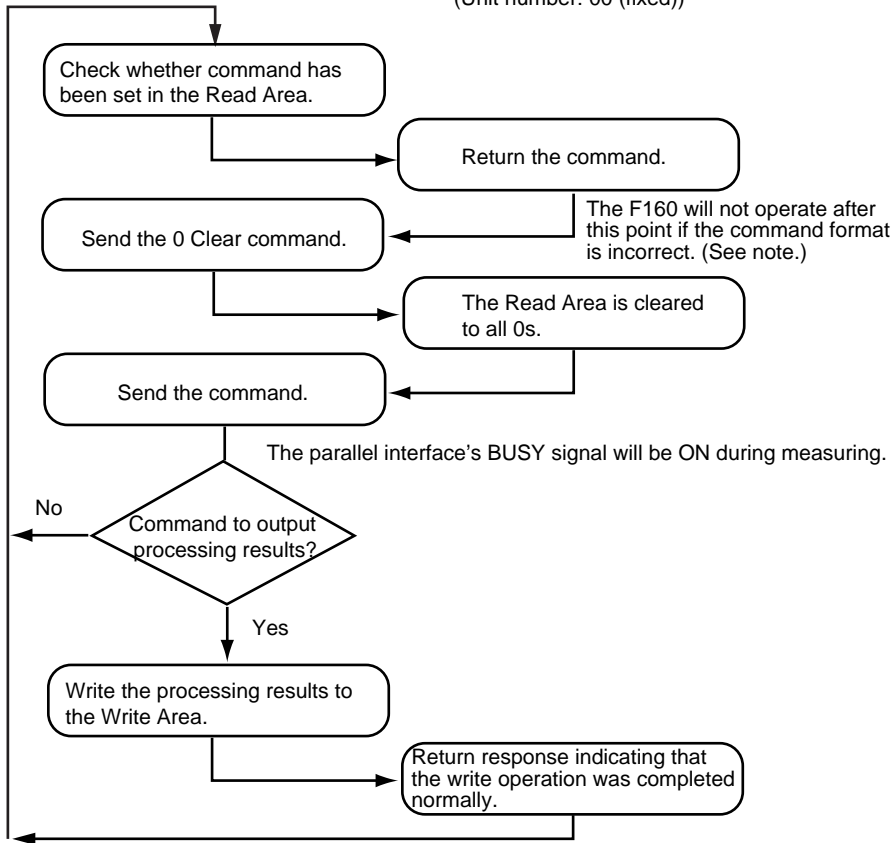

Note If a response is not received within 5 seconds, a timeout error will occur in the F160 because the PLC may be disconnected or malfunctioning. An error message will be displayed on the F160's screen and the parallel interface's ERR signal will be turned ON.

Inputting the Measurement Trigger from the STEP Signal

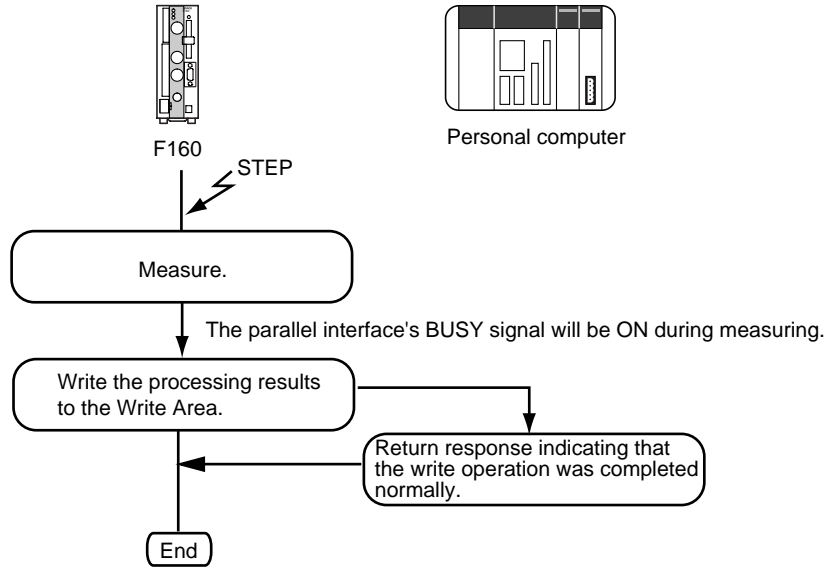

Note If a response is not received within 5 seconds, a timeout error will occur in the F160 because the PLC may be disconnected or malfunctioning. An error message will be displayed on the F160's screen and the parallel interface's ERR signal will be turned ON.

Using the TXD Instruction

With this method, the command is not set in the Read Area, it is actively transmitted from the PLC to the F160. Set the **Read area** to **None** in the **Communications (Host link)** window.

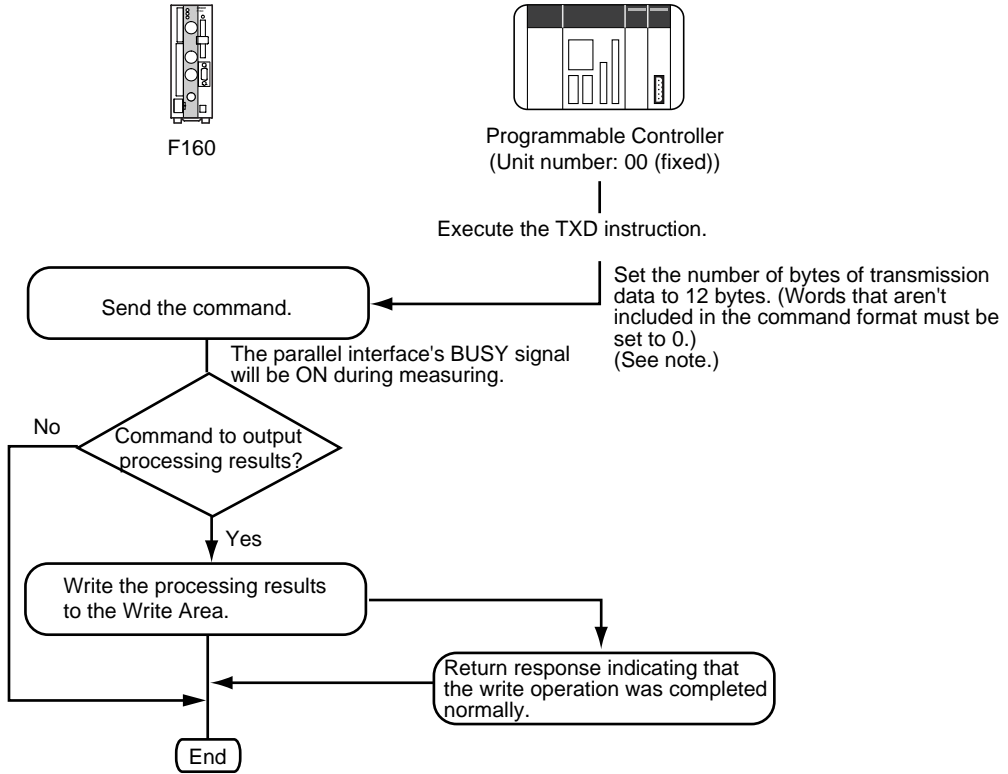

Note If a response is not received within 5 seconds, a timeout error will occur in the F160 because the PLC may be disconnected or malfunctioning. An error message will be displayed on the F160's screen and the parallel interface's ERR signal will be turned ON.

4-1-2 F160 Settings

Communications Speed and Communications Mode

Use the following procedure to set communications specifications such as the baud rate and data length. Set the same communications specifications in the F160 and the external device.

1. Move the cursor to **MON** or **RUN** and press the **ENT** Key.

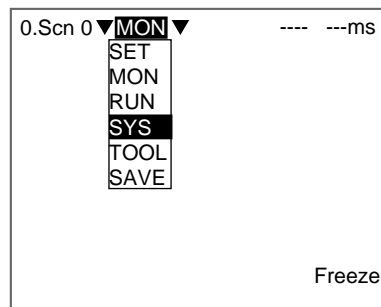

2. Select **SYS**.

The *System settings* menu will be displayed.

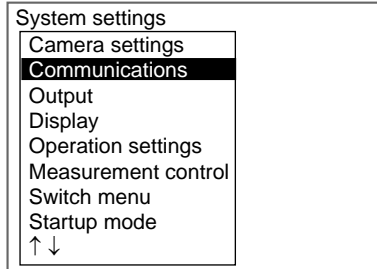

3. Select **Communications**.

The communications menu will be displayed.

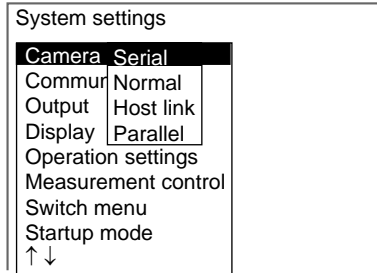

4. Select **Serial**.

The *Communications (Serial)* window will be displayed.

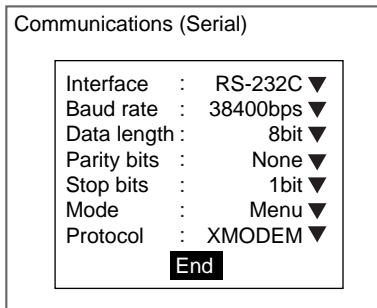

5. Set each parameter to the desired setting.

6. Select **End**.

The displayed settings will be registered and the *System settings* menu (from step 4) will be displayed.

The following table shows the possible communications settings. The asterisk indicates the factory default setting.

Item	Possible settings	
Interface	Select RS-232C . (from RS-232C* or RS-422)	
Baud rate	2,400, 4,800, 9,600, 19,200, 38,400*, 57,600, 115,200 (bps)	Set the same settings that are set in the PLC.
Data length	7 or 8* (bits)	
Parity bits	None*, Odd, or Even	
Stop bits	1* or 2 (bits)	
Mode	Select Host link . (from Menu, Normal*, or Host link)	
Protocol	XMODEM* or ZMODEM	

Note RS-232C standards are not defined for speeds over 20 kbps. Depending on the cable length, communications may be unreliable at speeds of 38,400 bps and higher when **RS-232C** is selected. If there are problems with communications, reduce the baud rate to 19,200 bps.

Settings Related to the Programmable Controller

Specify the location of the Read Area where the F160 reads commands and the location of the Write Area where the F160 outputs the execution results.

1. Select **Host link** communications

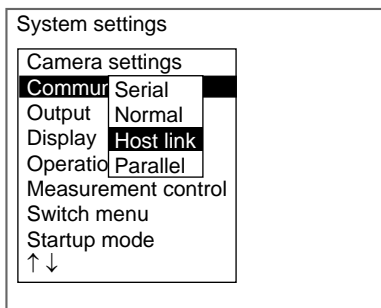

The *Communications (Host link)* window will be displayed.

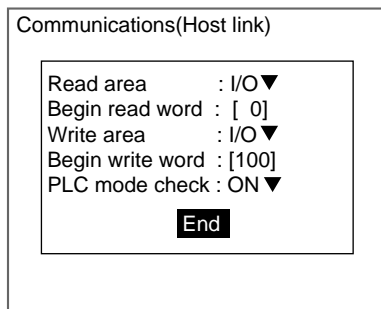

2. Set the locations of the Read and Write Areas.

SeeAlso

Refer to the *Expert Menu Operation Manual* or the *Conversational Menu Operation Manual* for details on inputting numbers.

3. Select **End**.

The new settings will be registered and the display will revert to the System settings window shown in step 1.

The following table explains the settings in the *Communications (Host link)* window. The asterisk indicates the factory default setting.

Item	Possible settings
Read area	Select the data area where the Read Area is located. The F160 checks the Read Area for commands. Select the IR (I/O) area*, HR area, LR area, DM area, or None. (If "None" is selected, the F160 won't read commands but will receive commands transmitted with the TXD instruction.)
Begin read word	Specify the Read Area's starting word address. (The setting range is 0 to 9995 and the default setting is 0.)
Write area	Select the data area where the Write Area is located. The F160 outputs execution results to the Write Area. Select the IR (I/O) area*, HR area, LR area, DM area, or None. (If "None" is selected, the F160 won't write execution results.)
Begin write word	Specify the Write Area's starting word address. (The setting range is 0 to 9996 and the default setting is 100.)

Item		Possible settings
PLC mode check	ON*	The PLC's operating mode is checked when the F160 enters Monitor Mode or Run Mode. Measurements won't start unless the PLC is in MONITOR mode. (An error message will be displayed at the F160.)
	OFF	When the F160 enters Monitor Mode or Run Mode, a mode change command is sent to the PLC to switch it to MONITOR mode.

4-2 Input Format (Host Link)

The following commands can be input from the host computer to the F160. Specify the command that you want to execute in the PLC's Read Area.

Commands that Control F160 Operations

Use the following commands to execute operations in the F160, such as executing measurements and switching scenes.

Command code	Function	Page
0010	Executes one measurement.	page 71
0011	Starts continuous measurement.	page 71
0012	Stops continuous measurement.	page 71
0020	Switches the scene number to the specified scene number.	page 71
0021	Increments (+1) the scene number being used.	page 72
0022	Decrements (-1) the scene number being used.	page 72
0030	Switches the scene group number to the specified scene group number.	page 73
0031	Increments (+1) the scene group number being used.	page 73
0032	Decrements (-1) the scene group number being used.	page 73
0040	Registers the model again.	page 73
0066	Saves the scene group data and system data that is being used.	page 74
0092	Resets the F160.	page 75

Commands that Read Measurement Results

Use the following commands to read the previous measurement results.

Command code	Function	Page
0080	Reads the measurement region's measurement results.	page 74
1210	Reads the position compensation region's measurement results.	page 78
1220	Reads the measurement results of the expression (variable).	page 79
1221	Reads the measurement results of the expression (data).	page 80
1222	Reads the measurement results of the expression (judgement).	page 80

Commands that Read Current Settings

Use the following commands to read settings such as judgement conditions. Operations can be specified that change a value while retrieving the F160's setting.

Command code	Function	Page
0023	Reads the scene number currently being used.	page 72
0033	Reads the scene group number currently being used.	page 73

Command code	Function	Page
1070	Reads the measurement region's parameters.	page 75
1110	Reads the judgement conditions for the expression (variable).	page 77
1111	Reads the judgement conditions for the expression (judgement).	page 77
1130	Reads the Intelligent Light's light levels.	page 78
1211	Reads the position compensation amount (scroll amount).	page 79

Commands that Change Current Settings

Use the following commands to change settings such as judgement conditions. Operations can be specified that change a value while retrieving the F160's setting.

Command code	Function	Page
1060	Sets the measurement region's parameters.	page 75
1100	Sets the judgement conditions for the expression (variable).	page 76
1101	Sets the judgement conditions for the expression (judgement).	page 76
1120	Sets the Intelligent Light's light levels.	page 78

Format (Host Link)

The commands are listed in order based on their command code. Input the commands in BCD format and set the commands in the Read Area. Bits that aren't used (listed as ---) are ignored, so these bits can be set to either 0 or 1.

0010: One-time Measurement

Executes one measurement.

Read Area word	Bits				Contents
	15 to 12	11 to 8	7 to 4	3 to 0	
+0	0000	0000	0001	0000	Command code

Set all bits in words +1 to +5 to 0.

Output: The measurement results are output.

0011: Start Continuous Measurement

Starts continuous measurement.

Read Area word	Bits				Contents
	15 to 12	11 to 8	7 to 4	3 to 0	
+0	0000	0000	0001	0001	Command code

Set all bits in words +1 to +5 to 0.

Output: The measurement results are output.

0012: Stop Continuous Measurement

Stops continuous measurement.

Read Area word	Bits				Contents
	15 to 12	11 to 8	7 to 4	3 to 0	
+0	0000	0000	0001	0010	Command code

Set all bits in words +1 to +5 to 0.

0020: Switch Scene (Specific Scene Number)

Switches the scene number to the specified scene number.

Read Area word	Bits				Contents
	15 to 12	11 to 8	7 to 4	3 to 0	
+0	0000	0000	0010	0000	Command code
+1	0000	0000	10s digit	1s digit	Scene number (00 to 31)

Set all bits in words +2 to +5 to 0.

0021: Switch Scene (Increment Scene Number by 1)

Increments the scene number currently being used. If the current scene number is 31, the scene number will rollover to 0.

Read Area word	Bits				Contents
	15 to 12	11 to 8	7 to 4	3 to 0	
+0	0000	0000	0010	0001	Command code

Set all bits in words +1 to +5 to 0.

0022: Switch Scene (Decrement Scene Number by 1)

Decrements the scene number currently being used. If the current scene number is 0, the scene number will rollover to 31.

Read Area word	Bits				Contents
	15 to 12	11 to 8	7 to 4	3 to 0	
+0	0000	0000	0010	0010	Command code

Set all bits in words +1 to +5 to 0.

0023: Read Scene Number

Reads the scene number currently being used.

Read Area word	Bits				Contents
	15 to 12	11 to 8	7 to 4	3 to 0	
+0	0000	0000	0010	0011	Command code

Set all bits in words +1 to +5 to 0.

Write Area word	Bits				Contents
	15 to 12	11 to 8	7 to 4	3 to 0	
+0	Write flags	0000	0000	0000	Write flag
+1	0000	0000	10s digit	1s digit	Scene number (00 to 31)

CHECK

Write Flags: Each time that data is output, the write flags are switched between "0000" and "1111". The status of these bits can be monitored to see when data has been written.

0030: Switch Scene Group (Specific Scene Group Number)

Switches the scene group number to the specified scene group number.

Read Area word	Bits				Contents
	15 to 12	11 to 8	7 to 4	3 to 0	
+0	0000	0000	0011	0000	Command code
+1	0000	0000	10s digit	1s digit	Scene group number (00 to 31)

Set all bits in words +2 to +5 to 0.

0031: Switch Scene Group (Increment Scene Group Number by 1)

Increments the scene group number currently being used. If the current scene group number is 31, the number will rollover to scene group 0.

Read Area word	Bits				Contents
	15 to 12	11 to 8	7 to 4	3 to 0	
+0	0000	0000	0011	0001	Command code

Set all bits in words +1 to +5 to 0.

0032: Switch Scene Group (Decrement Scene Group Number by 1)

Decrements the scene group number currently being used. If the current scene group number is 0, the number will rollover to scene group 31.

Read Area word	Bits				Contents
	15 to 12	11 to 8	7 to 4	3 to 0	
+0	0000	0000	0011	0010	Command code

Set all bits in words +1 to +5 to 0.

0033: Read Scene Group Number

Reads the scene group number currently being used.

Read Area word	Bits				Contents
	15 to 12	11 to 8	7 to 4	3 to 0	
+0	0000	0000	0011	0011	Command code

Set all bits in words +1 to +5 to 0.

Write Area word	Bits				Contents
	15 to 12	11 to 8	7 to 4	3 to 0	
+0	Write flags	0000	0000	0000	Write flag
+1	0000	0000	10 ¹ digit	10 ⁰ digit	Scene group number (00 to 31)

CHECK

Write Flags: Each time that data is output, the write flags are switched between "0000" and "1111". The status of these bits can be monitored to see when data has been written.

0040: Re-register Model

Registers the model again based on the image being displayed. (If a through display is being displayed, the model is registered again based on the last image that measured.)

The specified number is valid only if it is a Gray Search, Precise Search, Rotation Search, or Relative Search region number. Other region numbers will be ignored if they are specified.

Read Area word	Bits				Contents
	15 to 12	11 to 8	7 to 4	3 to 0	
+0	0000	0000	0100	0000	Command code
+1	0000	0000	10 ¹ digit	10 ⁰ digit	Region number (00 to 31)

Set all bits in words +2 to +5 to 0.

TwoCamera

The model registration is performed using the camera image that is currently being displayed, so execute this command after switching to the camera image for the region that you want to register again. Switch the camera image by pressing the Up and Down Arrow Keys on the Console.

SeeAlso

Refer to the *Expert Menu Operation Manual* for details.

0066: Data Save

Saves the scene group data and system data that is being used. System data and scene group 0 data (if scene group 0 is the current scene group) are saved to flash memory. The scene group data is saved to the Memory Card if the scene group number is between 1 and 31.

Read Area word	Bits				Contents
	15 to 12	11 to 8	7 to 4	3 to 0	
+0	0000	0000	0110	0110	Command code

Set all bits in words +1 to +5 to 0.

0080: Read the Measurement Region's Measurement Results

Reads the most recent measurement results.

The data codes are the same as the ones used for the MEASDATA command.

SeeAlso

Refer to *Data Code Tables (MEASDATA and POSIDATA)* on page 33 for details.

Read Area word	Bits				Contents
	15 to 12	11 to 8	7 to 4	3 to 0	
+0	0000	0000	1000	0000	Command code
+1	0000	0000	10 ¹ digit	10 ⁰ digit	Region number (00 to 31)
+2	10 ³ digit	10 ² digit	10 ¹ digit	10 ⁰ digit	Data code (0 to 9999)

Set all bits in words +3 to +5 to 0.

Write Area word	Bits				Contents
	15 to 12	11 to 8	7 to 4	3 to 0	
+0	Write flags	0000	0000	0000	Write flag
+1	10 ³ digit	10 ² digit	10 ¹ digit	10 ⁰ digit	Results data
+2	Sign	10 ⁶ digit	10 ⁵ digit	10 ⁴ digit	
+3	0000	10 ⁻¹ digit	10 ⁻² digit	10 ⁻³ digit	

CHECK Write Flags: Each time that data is output, the write flags are switched between "0000" and "1111". The status of these bits can be monitored to see when data has been written.
 Sign: Positive (0000) or negative (1111)

0092: Reset

Resets the F160.

Read Area word	Bits				Contents
	15 to 12	11 to 8	7 to 4	3 to 0	
+0	0000	0000	1001	0010	Command code

Set all bits in words +1 to +5 to 0.

1060: Set the Measurement Region's Parameters

Sets any one of the measurement region's parameters.

The data codes are the same as the ones used for the MEASPARA command.

SeeAlso Refer to *Data Code Tables (MEASPARA and POSIPARA)* on page 39 for details.

Read Area word	Bits				Contents
	15 to 12	11 to 8	7 to 4	3 to 0	
+0	0001	0000	0110	0000	Command code
+1	0000	0000	10 ¹ digit	10 ⁰ digit	Region number (00 to 31)
+2	10 ³ digit	10 ² digit	10 ¹ digit	10 ⁰ digit	Data code (0 to 9999)
+3	10 ³ digit	10 ² digit	10 ¹ digit	10 ⁰ digit	New setting
+4	Sign	10 ⁶ digit	10 ⁵ digit	10 ⁴ digit	
+5	0000	10 ⁻¹ digit	10 ⁻² digit	10 ⁻³ digit	

CHECK Sign: Positive (0000) or negative (1111)

1070: Read the Measurement Region's Parameters

Reads any one of the measurement region's parameters.

The data codes are the same as the ones used for the MEASPARA command.

SeeAlso Refer to *Data Code Tables (MEASPARA and POSIPARA)* on page 39 for details.

Read Area word	Bits				Contents
	15 to 12	11 to 8	7 to 4	3 to 0	
+0	0001	0000	0111	0000	Command code
+1	0000	0000	10 ¹ digit	10 ⁰ digit	Region number (00 to 31)
+2	10 ³ digit	10 ² digit	10 ¹ digit	10 ⁰ digit	Data code (0 to 9999)

Set all bits in words +3 to +5 to 0.

Write Area word	Bits				Contents
	15 to 12	11 to 8	7 to 4	3 to 0	
+0	Write flags	0000	0000	0000	Write flag
+1	10^3 digit	10^2 digit	10^1 digit	10^0 digit	Parameter data
+2	Sign	10^6 digit	10^5 digit	10^4 digit	
+3	0000	10^{-1} digit	10^{-2} digit	10^{-3} digit	

CHECK Write Flags: Each time that data is output, the write flags are switched between “0000” and “1111”. The status of these bits can be monitored to see when data has been written.
 Sign: Positive (0000) or negative (1111)

1100: Set Judgement Conditions for the Expression (Variable)

Sets the judgement conditions for the expression (variable).

Read Area word	Bits				Contents
	15 to 12	11 to 8	7 to 4	3 to 0	
+0	0001	0001	0000	0000	Command code
+1	0000	0000	0000	Type	Limit type
+2	0000	0000	10^1 digit	10^0 digit	Variable's expression number (00 to 31)
+3	10^3 digit	10^2 digit	10^1 digit	10^0 digit	New setting
+4	Sign	10^6 digit	10^5 digit	10^4 digit	
+5	0000	10^{-1} digit	10^{-2} digit	10^{-3} digit	

CHECK Limit type: Upper limit (0000) or lower limit (0001)
 Sign: Positive (0000) or negative (1111)

1101: Set Judgement Conditions for the Expression (Judgement)

Sets the judgement conditions for the expression (judgement).

Read Area word	Bits				Contents
	15 to 12	11 to 8	7 to 4	3 to 0	
+0	0001	0001	0000	0001	Command code
+1	0000	0000	0000	Type	Limit type
+2	0000	0000	10^1 digit	10^0 digit	Judgement's expression number (00 to 31)
+3	10^3 digit	10^2 digit	10^1 digit	10^0 digit	New setting
+4	Sign	10^6 digit	10^5 digit	10^4 digit	
+5	0000	10^{-1} digit	10^{-2} digit	10^{-3} digit	

CHECK Limit type: Upper limit (0000) or lower limit (0001)
 Sign: Positive (0000) or negative (1111)

1110: Read Judgement Conditions for the Expression (Variable)

Reads the judgement conditions for the expression (variable).

Read Area word	Bits				Contents
	15 to 12	11 to 8	7 to 4	3 to 0	
+0	0001	0001	0001	0000	Command code
+1	0000	0000	0000	Type	Limit type
+2	0000	0000	10 ¹ digit	10 ⁰ digit	Variable's expression number (00 to 31)

Set all bits in words +3 to +5 to 0.

CHECK

Limit type: Upper limit (0000) or lower limit (0001)

Write Area word	Bits				Contents
	15 to 12	11 to 8	7 to 4	3 to 0	
+0	Write flags	0000	0000	0000	Write flag
+1	10 ³ digit	10 ² digit	10 ¹ digit	10 ⁰ digit	Read data
+2	Sign	10 ⁶ digit	10 ⁵ digit	10 ⁴ digit	
+3	0000	10 ⁻¹ digit	10 ⁻² digit	10 ⁻³ digit	

CHECK

Write Flags: Each time that data is output, the write flags are switched between "0000" and "1111". The status of these bits can be monitored to see when data has been written.

Sign: Positive (0000) or negative (1111)

1111: Read Judgement Conditions for the Expression (Judgement)

Reads the judgement conditions for the expression (judgement).

Read Area word	Bits				Contents
	15 to 12	11 to 8	7 to 4	3 to 0	
+0	0001	0001	0001	0001	Command code
+1	0000	0000	0000	Type	Limit type
+2	0000	0000	10 ¹ digit	10 ⁰ digit	Judgement's output number (00 to 31)

Set all bits in words +3 to +5 to 0.

CHECK

Limit type: Upper limit (0000) or lower limit (0001)

Write Area word	Bits				Contents
	15 to 12	11 to 8	7 to 4	3 to 0	
+0	Write flags	0000	0000	0000	Write flags
+1	10 ³ digit	10 ² digit	10 ¹ digit	10 ⁰ digit	Read data
+2	Sign	10 ⁶ digit	10 ⁵ digit	10 ⁴ digit	
+3	0000	10 ⁻¹ digit	10 ⁻² digit	10 ⁻³ digit	

CHECK

Write Flags: Each time that data is output, the write flags are switched between "0000" and "1111". The status of these bits can be monitored to see when data has been written.

Sign: Positive (0000) or negative (1111)

1120: Change Intelligent Light's Light Levels

Sets the Intelligent Light's light levels.

Read Area word	Bits				Contents
	15 to 12	11 to 8	7 to 4	3 to 0	
+0	0001	0001	0010	0000	Command code
+1	0000	0000	0000	Camera	Camera number (0 or 1)
+2	0000	0000	0000	0000	Set to 0000.
+3	Area B	Area C	Area D	Area E	New light level settings for areas A through H (0 to 7, 0 is OFF)
+4	0000	0000	0000	Area A	
+5	0000	Area F	Area G	Area H	

F150-LTC20,
F160-LTC20



(Set the light levels to 0 in areas F through H.)

F150-LTC50,
F160-LTC50

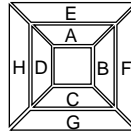

1130: Read Intelligent Light's Light Levels

Reads the Intelligent Light's light levels.

Read Area word	Bits				Contents
	15 to 12	11 to 8	7 to 4	3 to 0	
+0	0001	0001	0011	0000	Command code
+1	0000	0000	0000	Camera	Camera number (0 or 1)

Set all bits in words +2 to +5 to 0.

Write Area word	Bits				Contents
	15 to 12	11 to 8	7 to 4	3 to 0	
+ 0	Write flags	0000	0000	0000	Write flags
+ 1	Area B	Area C	Area D	Area E	Light level settings for areas A through H (0 to 7, 0 is OFF)
+ 2	0000	0000	0000	Area A	
+ 3	0000	Area F	Area G	Area H	

CHECK

Write Flags: Each time that data is output, the write flags are switched between "0000" and "1111". The status of these bits can be monitored to see when data has been written.

1210: Read Position Compensation Region's Measurement Results

Reads the position compensation region's measurement results.

Read Area word	Bits				Contents
	15 to 12	11 to 8	7 to 4	3 to 0	
+0	0001	0010	0001	0000	Command code
+1	0000	0000	0000	Region	Region number (0 to 7)
+2	0000	0000	10 ¹ digit	10 ⁰ digit	Data code (0 to 13)

Set all bits in words +3 to +5 to 0.

Write Area word	Bits				Contents
	15 to 12	11 to 8	7 to 4	3 to 0	
+0	Write flags	0000	0000	0000	Write flags
+1	10^3 digit	10^2 digit	10^1 digit	10^0 digit	Read data
+2	Sign	10^6 digit	10^5 digit	10^4 digit	
+3	0000	10^{-1} digit	10^{-2} digit	10^{-3} digit	

CHECK Write Flags: Each time that data is output, the write flags are switched between “0000” and “1111”. The status of these bits can be monitored to see when data has been written.

Sign: Positive (0000) or negative (1111)

1211: Read Position Compensation Amount

Reads the position compensation amount (scroll amount).

SeeAlso The position compensation number and data code are the same as parameters 1 and 2 of the POSIAMNT command for normal communications. Refer to page 52 for details.

Read Area word	Bits				Contents
	15 to 12	11 to 8	7 to 4	3 to 0	
+0	0001	0010	0001	0001	Command code
+1	0000	0000	0000	Number	Position compensation number (0 to 3)
+2	0000	0000	0000	Code	Data code (0 to 2)

Set all bits in words +3 to +5 to 0.

Write Area word	Bits				Contents
	15 to 12	11 to 8	7 to 4	3 to 0	
+0	Write flags	0000	0000	0000	Write flags
+1	10^3 digit	10^2 digit	10^1 digit	10^0 digit	Read data
+2	Sign	10^6 digit	10^5 digit	10^4 digit	
+3	0000	10^{-1} digit	10^{-2} digit	10^{-3} digit	

CHECK Write Flags: Each time that data is output, the write flags are switched between “0000” and “1111”. The status of these bits can be monitored to see when data has been written.

Sign: Positive (0000) or negative (1111)

1220: Read Measurement Results of Expression (Variable)

Reads the measurement results of the expression (variable).

Read Area word	Bits				Contents
	15 to 12	11 to 8	7 to 4	3 to 0	
+0	0001	0010	0010	0000	Command code
+1	0000	0000	10^1 digit	10^0 digit	Variable's expression number (00 to 31)

Set all bits in words +2 to +5 to 0.

Write Area word	Bits				Contents
	15 to 12	11 to 8	7 to 4	3 to 0	
+0	Write flags	0000	0000	0000	Write flags
+1	10^3 digit	10^2 digit	10^1 digit	10^0 digit	Read data
+2	Sign	10^6 digit	10^5 digit	10^4 digit	
+3	0000	10^{-1} digit	10^{-2} digit	10^{-3} digit	

CHECK Write Flags: Each time that data is output, the write flags are switched between “0000” and “1111”. The status of these bits can be monitored to see when data has been written.
 Sign: Positive (0000) or negative (1111)

1221: Read Measurement Results of Expression (Data)

Reads the most recent measurement results.

Read Area word	Bits				Contents
	15 to 12	11 to 8	7 to 4	3 to 0	
+0	0001	0010	0010	0001	Command code
+1	0000	0000	10^1 digit	10^0 digit	Data output number (00 to 31)

Set all bits in words +2 to +5 to 0.

Write Area word	Bits				Contents
	15 to 12	11 to 8	7 to 4	3 to 0	
+0	Write flags	0000	0000	0000	Write flags
+1	10^3 digit	10^2 digit	10^1 digit	10^0 digit	Read data
+2	Sign	10^6 digit	10^5 digit	10^4 digit	
+3	0000	10^{-1} digit	10^{-2} digit	10^{-3} digit	

CHECK Write Flags: Each time that data is output, the write flags are switched between “0000” and “1111”. The status of these bits can be monitored to see when data has been written.
 Sign: Positive (0000) or negative (1111)

1222: Read Measurement Results of Expression (Judgement)

Reads the most recent measurement results.

Read Area word	Bits				Contents
	15 to 12	11 to 8	7 to 4	3 to 0	
+0	0001	0010	0010	0010	Command code
+1	0000	0000	10^1 digit	10^0 digit	Judgement output number (00 to 31)

Set all bits in words +2 to +5 to 0.

Write Area word	Bits				Contents
	15 to 12	11 to 8	7 to 4	3 to 0	
+0	Write flags	0000	0000	0000	Write flags
+1	10 ³ digit	10 ² digit	10 ¹ digit	10 ⁰ digit	Read data
+2	Sign	10 ⁶ digit	10 ⁵ digit	10 ⁴ digit	
+3	0000	10 ⁻¹ digit	10 ⁻² digit	10 ⁻³ digit	

CHECK Write Flags: Each time that data is output, the write flags are switched between "0000" and "1111". The status of these bits can be monitored to see when data has been written.
 Sign: Positive (0000) or negative (1111)

4-3 Output Format (Host Link)

When measurements have been executed, the measurement results are output to the PLC's Write Area in BCD format.

Each time that data is output, the write flags are switched between "0000" and "1111". The status of these bits can be monitored to see when data has been written.
 After the first measurement, the write flags are cleared to "1111" so store "0000" in this digit as the initial value before starting measurements.

Write Area word	Bits				Contents
	15 to 12	11 to 8	7 to 4	3 to 0	
+0	Write flags	0000	0000	0000	Write flags
+1	10 ³ digit	10 ² digit	10 ¹ digit	10 ⁰ digit	Read data
+2	Sign	10 ⁶ digit	10 ⁵ digit	10 ⁴ digit	
+3	0000	10 ⁻¹ digit	10 ⁻² digit	10 ⁻³ digit	

0000: Positive
 1111: Negative

Output Data

- **Digital Output Range**
 -9,999,999.999 ≤ measurement ≤ 9,999,999.999
 The minimum value of "-9,999,999.999" will be output for measurements less than -9,999,999.999.
 The maximum value of "9,999,999.999" will be output for measurements greater than 9,999,999.999.
- **JG (Judgement) Outputs**
 The following values are output when JG (Judgement) has been set:
 OK: 0
 NG: -1

CHECK After measurements have been made in Run Mode, the data up through the last measurement will be output even if the mode is changed to another mode. The data output will not be interrupted midway.

Example 1

This example shows the data output when the data 0 measurement is 143.250, data 1 is not set, and the data 2 measurement is -6,943.298.

Data	Write Area word	Bits				Contents
		15 to 12	11 to 8	7 to 4	3 to 0	
Data 0	+0	0000	0000	0000	0000	Write flags (0000)
	+1	0000	0001	0100	0011	Four lowest integer digits
	+2	0000	0000	0000	0000	Sign and three highest integer digits
	+3	0000	0010	0101	0000	Three digits after decimal point
Data 2	+4	0000	0000	0000	0000	Write flags (0000)
	+5	0110	1001	0100	0011	Four lowest integer digits
	+6	1111	0000	0000	0000	Sign and three highest integer digits
	+7	0000	0010	1001	1000	Three digits after decimal point

CHECK Output numbers that have not been set, such as data 1 in the example above, are omitted from the data output.

Example 2

The results for up to 7 data elements can be output at one time. If 8 or more output numbers have been set, the data will be output in groups of 7 elements max.

In this example, output numbers 0 through 7 have been set. The results for data 0 to data 6 are output the first time and the results for data 7 are output the second time.

Data	Write Area word	Bits				Contents
		15 to 12	11 to 8	7 to 4	3 to 0	
First batch: Data 0 to data 6	+0	0000	0000	0000	0000	Write flags (0000)
	+1	0000	0001	0100	0011	Measurement result
	+2	0000	0000	0000	0000	
	+3	0000	0010	0101	0000	
	:	:	:	:	:	
	:	:	:	:	:	:
	+(4yn)+0	0000	0000	0000	0000	Write flags (0000)
	+(4yn)+1	0110	1001	0100	0011	Measurement result
	+(4yn)+2	1111	0000	0000	0000	
	+(4yn)+3	0000	0010	1001	1000	
:	:	:	:	:	:	
:	:	:	:	:	:	
Second batch: Data 7	+28	0000	0000	0000	0000	Write flags (0000)
	+29	0000	0001	0110	0011	Measurement result
	+30	0000	0000	0000	0000	
	+31	0000	0010	0101	0000	

4-4 Sample Ladder Program

This sample program is compatible with OMRON C200H, C200HS, and CQM1 PLCs. The F160 inputs a measurement command from the PLC's Read Area and outputs the judgement results to the PLC's Write Area.

PLC Settings

The following communications conditions are set for the PLC's host link port. This port may be in the PLC's CPU Unit or a Host Link Unit. Refer to the PLC's Operation Manual for details on setting the host link communications parameters.

Item	Setting
Communications mode	Host link
Connection (1:1 or 1:N)	1:N connection
Node number	00
Baud rate	Same as the settings in the F160.
Data length	
Parity bits	
Stop bits	

F160 Settings

The communications conditions and expression settings are as follows.

Communications Settings

Item	Setting
Baud rate	Same as the settings in the PLC.
Data length	
Parity bits	
Stop bits	
Read area	DM
Begin read word	0100
Write area	DM
Begin write word	0106

Expression Settings

Set the following expressions for data 0 and data 1 in **Expression/Data**.

Data 0: R0.JG

Data 1: R1.JG

DM Area Allocation in the PLC

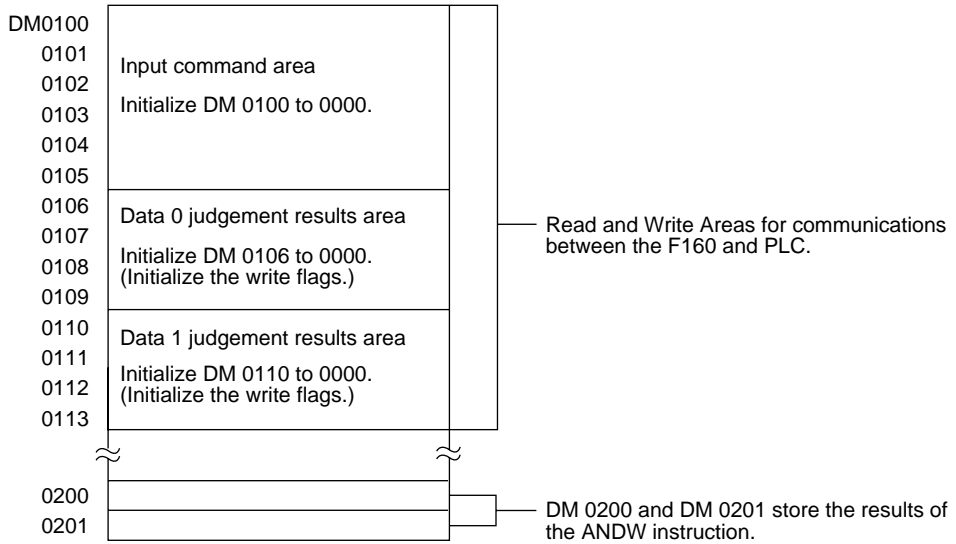

Ladder Program

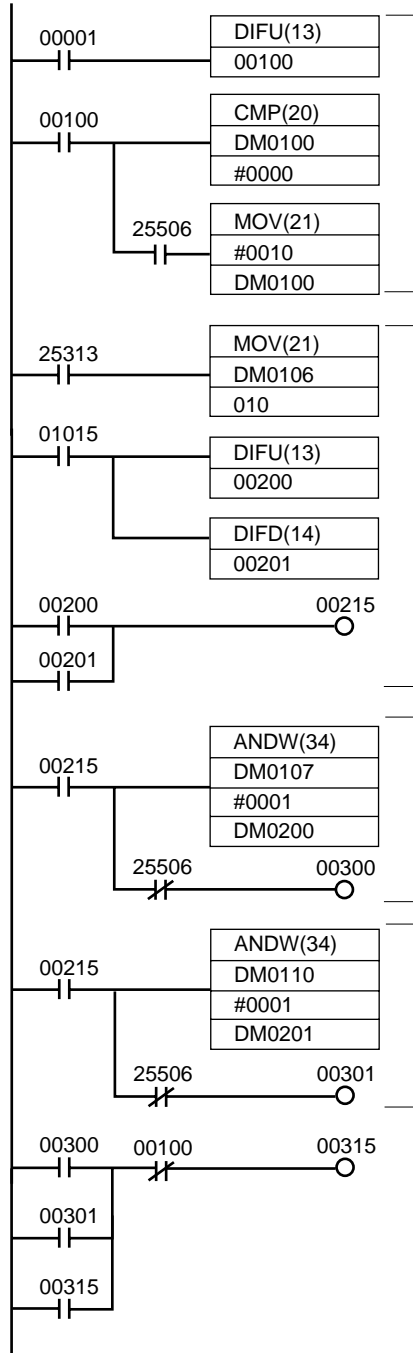

When the external switch (IR 00001) goes from OFF to ON, the measurement command (0010) is written to the input command area if the area was cleared to 0000.

Detects a change in the status of the data 0 write flags.

If the first digit of the data 0 judgement result is equal to 1, IR 00300 is turned ON to indicate an NG (no good) result.

If the first digit of the data 1 judgement result is equal to 1, IR 00301 is turned ON to indicate an NG (no good) result.

The NG results for data 0 and data 1 are ORed and the result is output to IR 00315. This result is maintained until the next measurement.

Index

A

- Area (var. box)
 - reading and writing data, 41

C

- Classification
 - reading and writing data, 47
- commands
 - Host Link
 - 0010 (One-time Measurement), 71
 - 0011 (Start Continuous Measurement), 71
 - 0012 (Stop Continuous Measurement), 71
 - 0020 (Switch Scene for Specific Scene Number), 71
 - 0021 (Switch Scene by Incrementing Scene Number), 72
 - 0022 (Switch Scene by Decrementing Scene Number), 72
 - 0023 (Read Scene Number), 72
 - 0030 (Switch Scene Group to Specific Scene Group Number), 73
 - 0031 (Switch Scene Group by Incrementing Scene Group Number), 73
 - 0032 (Switch Scene Group by Decrementing Scene Group Number), 73
 - 0033 (Read Scene Group Number), 73
 - 0040 (Re-register Model), 73
 - 0066 (Data Save), 74
 - 0080 (Read the Measurement Region's Measurement Results), 74
 - 1060 (Set the Measurement Region's Parameters), 75
 - 1070 (Read the Measurement Region's Parameters), 75
 - 1100 (Set Judgement Conditions for the Expression Variable), 76
 - 1101 (Set Judgement Conditions for the Expression Judgement), 76
 - 1110 (Read Judgement Conditions for the Expression Variable), 77
 - 1111 (Read Judgement Conditions for the Expression Judgement), 77
 - 1120 (Change Intelligent Light's Light Levels), 78
 - 1130 (Read Intelligent Light's Light Levels), 78
 - 1210 (Read Position Compensation Region's Measurement Results), 78
 - 1211 (Read Position Compensation Amount), 79

- 1220 (Read Measurement Results of Expression Variable), 79
- 1221 (Read Measurement Results of Expression Data), 80
- 1222 (Read Measurement Results of Expression Judgement), 80
- changing current settings, 71
- controlling F160 operation, 70
- formats, 71
- reading current settings, 70
- reading measurement results, 70
- normal serial interface
 - controlling F160 operation, 24
 - DATASAVE, 26
 - DATE, 26
 - DISPCOND, 27, 28
 - DISPIMG, 28
 - EXP, 29
 - EXPPARA, 29
 - IMGLOAD, 30
 - IMGLOADM, 30
 - IMGSAVE, 31
 - IMGSAVEM, 31
 - LITPARA, 32
 - MEASDATA, 33
 - MEASPARA, 38
 - MEASURE, 50
 - MENUKEY, 51
 - MODELSET, 51
 - PASSWORD, 52
 - POSIAMNT, 53
 - POSIDATA, 53
 - POSIPARA, 54
 - reading and changing current status, 25
 - reading measurement results, 24
 - RESET, 55
 - saving and loading data, 25
 - SCENE, 55
 - SCNGROUP, 57
 - SCNLOAD, 55
 - SCNLOADM, 56
 - SCNSAVE, 56
 - SCNSAVEM, 57
 - SGRLOAD, 58
 - SGRLOADM, 58
 - SGRSAVE, 59
 - SGRSAVEM, 59
 - SYSLOAD, 59
 - SYSLOADM, 60

SYSSAVE, 60
SYSSAVEM, 61
VERGET, 61
communications
 setting, 2, 14, 19, 64
 settings from F160, 67
 settings in F160, 21
communications procedure
 normal serial interface, 19
computers
 inputting characters, 16
 key inputs and Console keys, 15
conversational menus
 output format, 5

D

Defect
 reading and writing data, 40
Defect (var. box)
 reading and writing data, 43
Density Data
 reading and writing data, 45
DI0 to DI9, 4

E

Edge Pitch
 reading and writing data, 45
Edge Position
 reading and writing data, 42
Edge Width
 reading and writing data, 44
expert menus
 output format, 5

F

Flexible Search
 reading and writing data, 47

G

Gravity and Area
 reading and writing data, 39
Gravity and Axis
 reading and writing data, 39
Gray Search
 reading and writing data, 46

H

Host Link, 63
 output format, 81
 sample program, 83

I

I/O format, 4
input format, 4
 Host Link, 70
 normal serial communications, 24

L

Labeling
 reading and writing data, 50
ladder program
 sample for Host Link communications, 83

M

manuals, ix
measurement trigger, 66

O

OCR for One Character
 reading and writing data, 48
output format, 4
 Host Link, 81
 normal serial interface, 61

P

parallel interface, 1
Precise Search
 reading and writing data, 45
procedure
 Host Link communications, 65
Programmable Controller
 settings, 69

R

Relative Search
 reading and writing data, 48
Rotation Search
 reading and writing data, 47

S

serial interface, 13
 normal, 17
specifications
 setting, 2, 14, 19, 64
STEP signal, 4

T

timing charts, 5
TXD instruction, 67

Revision History

A manual revision code appears as a suffix to the catalog number on the front cover of the manual.

Cat. No. Z172-E1-02A

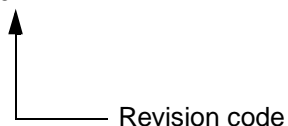

The following table outlines the changes made to the manual during each revision. Page numbers refer to the previous version.

Revision code	Date	Revised content
01	February 2003	Original production
01A	February 2004	Page ix: Removed suffixes from model numbers. Page 10: Bottom portion of timing chart changed. Page 31: Information added to <i>CHECK</i> section. Pages 56 and 60: Information added to <i>CHECK</i> section at bottom of page.
01B	July 2004	Information on warranty and limitations of liability added to the front of the manual.
02	May 2005	Information on warranty and liability at the front of the manual updated.
02A	June 2006	Page 54: Output corrected for function 2.

OMRON

OMRON Corporation
Industrial Automation Company

Sensing Devices Division H.Q.
Application Sensors Division
Shiokoji Horikawa, Shimogyo-ku,
Kyoto, 600-8530 Japan
Tel: (81)75-344-7068/Fax: (81)75-344-7107

Regional Headquarters

OMRON EUROPE B.V.
Sensor Business Unit,
Carl-Benz-Str. 4, D-71154 Nufringen,
Germany
Tel: (49)7032-811-0/Fax: (49)7032-811-199

OMRON ELECTRONICS LLC
1 East Commerce Drive, Schaumburg, IL 60173
U.S.A.
Tel: (1)847-843-7900/Fax: (1)847-843-8568

OMRON ASIA PACIFIC PTE. LTD.
83 Clemenceau Avenue,
#11-01, UE Square,
239920 Singapore
Tel: (65)6835-3011/Fax: (65)6835-2711

OMRON (CHINA) CO., LTD.
Room 2211, Bank of China Tower,
200 Yin Cheng Road (M),
Shanghai, 200120 China
Tel: (86)21-5037-2222/Fax: (86)21-5037-2200

Authorized Distributor: